

# FTTX

Principles, Technologies and Installation Solutions



# nestor cables



## Nestor Cables – Quality from Finland

Nestor Cables develops, manufactures and sells both optical and copper telecommunication, industrial and special cables as well as fibre optic cable accessories.

### Nestor Cables offers to their customers around the world:

- Complete network solutions, including the needed cables and accessories
- High quality
- On-time deliveries
- Flexible lead times
- Products suitable even for challenging circumstances
- Customer oriented service
- Innovativeness



[www.nestorcables.com](http://www.nestorcables.com)



# FTTX

Principles, Technologies and Installation Solutions





# Contents

<b>Preface</b>	<b>5</b>
<b>1 Introduction to optical networks</b>	<b>6</b>
1.1 Access network as a part of the public telecommunications network	6
1.2 Clarification of FTTX terms	8
1.3 Optical fibre as a transmission medium	9
1.4 Standards	12
<b>2 Optical fibres</b>	<b>15</b>
2.1 Light propagation in optical fibre	15
2.2 Basic fibre types	16
2.3 Materials and mechanical characteristics of optical fibres	19
2.4 Optical characteristics of optical fibres	21
<b>3 Optical fibre cables</b>	<b>29</b>
3.1 Cable constructions	29
3.2 Differences between outdoor and indoor cables	34
3.3 Mechanical and environmental characteristics of cables	35
3.4 Colour coding of fibres	39
<b>4 Optical fibre connecting hardware, other passive components and mechanical constructions</b>	<b>42</b>
4.1 Optical fibre connectors	42
4.2 Other passive components	50
4.3 Optical fibre termination boxes, patch panels and distributor mechanics	52
4.4 Joint closures and cabinets	55
<b>5 Transmission technologies and network topologies</b>	<b>58</b>
5.1 Overview of optical fibre transmission technologies	58
5.2 Basic network topologies	65
5.3 Point-to-point Ethernet topologies	66
5.4 Point-to-multipoint topologies or passive network topologies	69
5.5 Active components used in optical networks	79
<b>6 Planning of optical access network</b>	<b>83</b>
6.1 Structure and functional elements of optical access network	83
6.2 Tasks and importance of planning	84
6.3 Physical topology and numbers of fibres	85
6.4 Choosing criteria and specification of components	91
6.5 Attenuation calculations	93
6.6 Planning documents	95
6.7 Customer premises networks	96
<b>7 Installation of optical fibre cable</b>	<b>101</b>
7.1 Handling of cable	101
7.2 Installation practices of cables	103
7.3 Lightning protection	115
7.4 Considering other use of installation environment and bringing the cable to site	116
<b>8 Splicing, jointing and termination of optical fibre cable</b>	<b>117</b>
8.1 Splicing of optical fibres	117
8.2 Jointing solutions	120
8.3 Termination of optical fibres	123
8.4 Quality of fibre connections	124
8.5 Distributor installations	125
8.6 Building entrance and termination of outdoor cables	127
8.7 Safety	128

<b>9 Measurements of optical fibre links</b>	<b>130</b>
9.1 Measurement of attenuation with OTDR	130
9.2 Measurement of attenuation with light source and power meter	133
9.3 Fibre continuity test	135
9.4 Cleanliness	135
9.5 Saving and documentation of measurement results	136
<b>10 Documentation and maintenance</b>	<b>137</b>
10.1 Documentation	137
10.2 Maintenance	137
<b>Appendix 1: Abbreviations</b>	<b>141</b>

## Preface

Optical access networks are widely constructed all over the world. The transmission capacity of current copper access lines is not satisfactory for the new demand. We are already now living in the e-society. Telecommunications services can be used for wide range of services earlier carried out by other means. In most of the cases it meant travelling, mailing, calling, etc and especially a lot of working hours.

In Finland there is a national program targeting to have 100 Mbit/s services available to 99 % of the population by 2015. The target is challenging but achievable as the need for such a program is commonly understood and accepted. Such broadband programs exist in several other countries as well. The main network infrastructure will be based on optical fibre. The optical fibre may reach homes (FTTH), buildings (FTTB) or some other nodes close to the home. Acronym FTTx is indicating this approach.

Nestor Cables is developing products as well as whole concepts in order to support these programs. As part of the FTTx support this book is published. The book will give the readers comprehensive review of the optical access network architectures, network structures, optical fibre cables and other components and also the most common installation and working methods. Properly planned and constructed fibre network is easily maintained and upgraded to future needs – it gives the best value for the money.

This book was written first time by Pekka Koivisto (MSc, Pekka Koivisto Ltd) in 2010. Now this book has been updated by Pekka Koivisto for covering new solutions like new cable types and installations methods for building optical access networks. Nestor Cables has supported the author for the content of this book.

We at Nestor Cables hope that this book will be useful for all of you dealing with optical access networks and it will ease the construction of the modern information society.

Oulu, April 15th, 2015

Nestor Cables Ltd.

Seppo Marttila

Technology Manager



# 1 Introduction to optical networks

## 1.1 Access network as a part of the public telecommunications network

During the last decades the transmission technologies used in telecommunications networks have been developing continuously in each level of the network: core network, regional network, access network and customer premises networks. The increasing use of telecommunications applications and services has always been the driving force for this development. And this growth seems to continue also in future.

Modern telecommunications systems are digital and the capacity of transmission is expressed in bits per second (bit/s). Such units as gigabits per second (Gbit/s) and terabits per second (Tbit/s) are no more uncommon, when kilobits per second (kbit/s) and megabits per second (Mbit/s) are no more sufficient. It was not very long time ago – only 35 years – when the capacity of telecommunications network was described by the number of simultaneous telephone calls. One development era was culminated in 60 MHz analogue coaxial cable transmission system, which was able to transmit simultaneously 10800 telephone calls in the core network. At the same time the development of optical fibre transmission technology began to be at such a stage that the optical fibre cable was able to challenge the coaxial cable and very soon also to replace it. The use of the optical fibre cable expanded rapidly in the 1980's from core network to lower levels of the network. This was to mean that optical fibre cables began to replace copper cable PCM-systems in transmission systems between telephone exchanges (central offices). The next and natural phase was the penetration of fibre optic technology to the access network. Figure 1.1 illustrates the expanding use of fibre optic technology in different parts of the public telecommunications network during the last few decades.

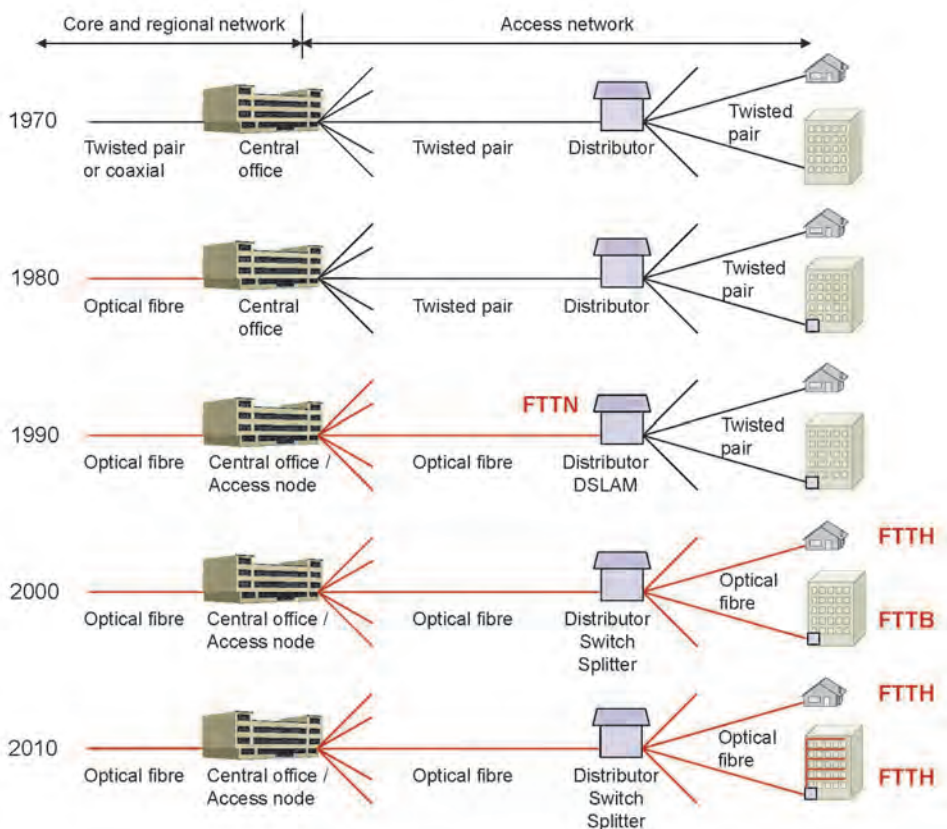

Figure 1.1. Expanding use of optical fibre cables in different levels of the public telecommunications network during the last five decades.



The modern public telecommunications network can be divided into three levels:

- Core network or Wide Area Network (WAN)
- Regional Network or Metropolitan Area Network (MAN)
- Access Network or Subscriber Network

These levels are illustrated in figure 1.2.

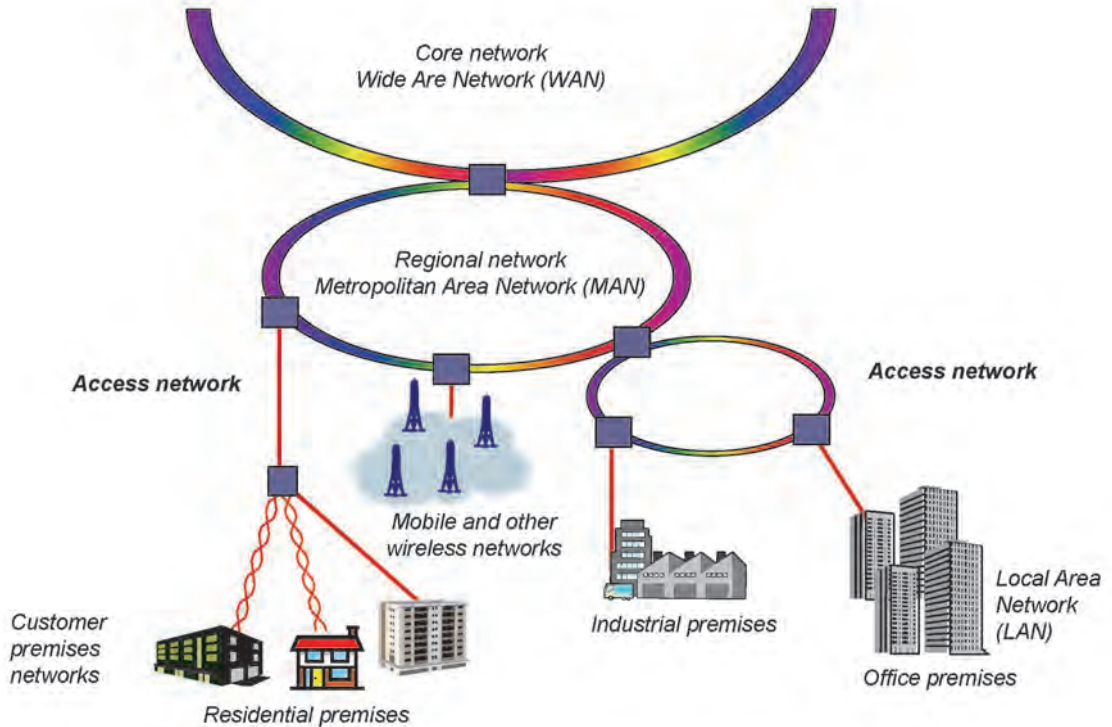

Figure 1.2. The three levels of the modern public telecommunications network.

The access network is commonly defined as that part of the public telecommunications network, to which the customers and customer premises networks are connected. Another name for this part of network is subscriber network. In this book, however, access network is preferred and used. There is a great variety of technologies used for broadband access. The most common broadband access technologies are the following:

- XDSL (DSL = Digital Subscriber Line)
  - ADSL, ADSL2, ADSL 2+
  - SHDSL
  - VDSL2
  - G.fast
- Fibre To The Node (FTTN), Fibre to The Building (FTTB), Fibre To The Home (FTTH)
- Cable television (Cable TV) and cable modem technology
  - Hybrid Fibre Coaxial (HFC)
  - RF over Glass (RFoG)
- Wireless
  - WLAN, Wimax
  - Mobile networks (3G, LTE, 4G)

Figure 1.3 shows examples of the above mentioned access technologies.

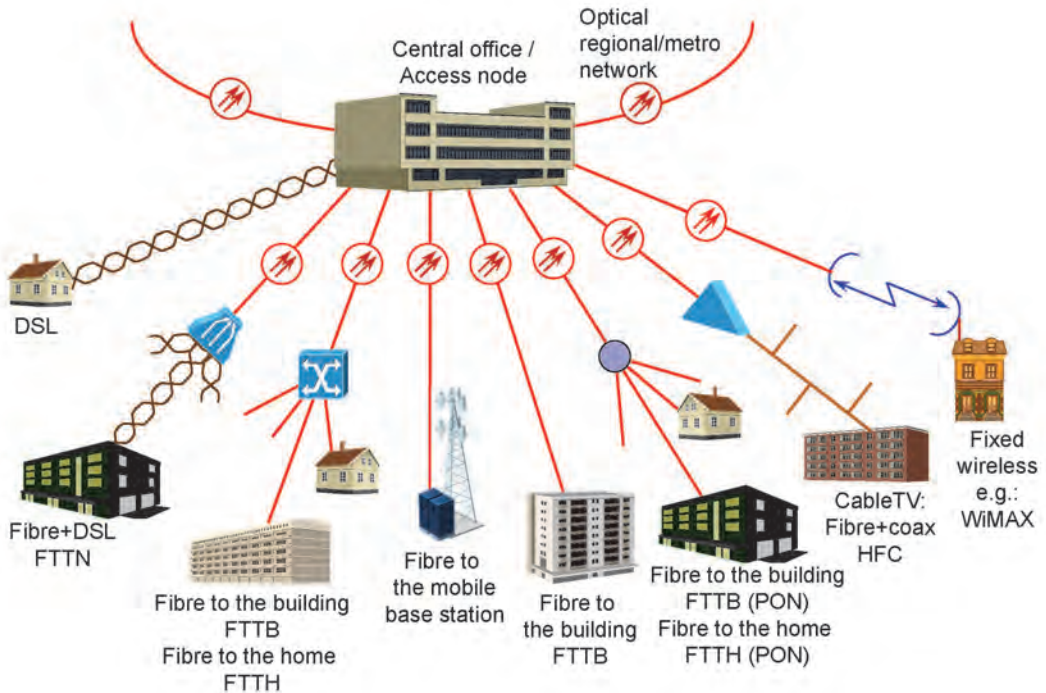

Figure 1.3. Examples of broadband access technologies.

The final penetration of fibre optic technology to the access network has proved to take much more time the development in core and regional networks in 1980's and 1990's. There are several reasons for this. Two most important reasons may be mentioned here. The structure and topology of the access network is such, that building of access network is much more expensive per customer than that of the core and regional network. On the other hand the xDSL-technologies, which were developed in 1990's and which are still under further development, have enabled utilizing of the copper access networks in such a way that it is possible to bring tens of Mbit/s or even more to the customer. The need of transmission capacity, however, continuously grows and the limits of the copper will be reached someday. Therefore during recent years the deployment of optical access networks has started in many countries. This progress is also supported by the key technologies, which are Ethernet and IP. Most connections of consumers and companies begin and end with IP over Ethernet. The use of Ethernet has expanded from Local Area Networks (LAN) also to Metropolitan Area Networks (MAN), to Wide Area Networks (WAN) and finally to access networks. Ethernet and IP together with fibre optic transmission and WDM make it possible to implement the real multiservice network – not only broadband Internet access. In this network the convergence of data, telephone and TV-broadcast with all the associated services will be realized.

## 1.2 Clarification of FTTX terms

A great variety of FTTX terms are used to describe the extension of the fibre in the access network. These different terms may cause confusion, if they have not been not well defined. In fact, however, not many terms are required to cover all situations. FTTH council has defined only two terms: FTTH and FTTB. In this book we define the following three terms:

- **FTTH** = Fibre to the home
  - Fibre extends to a single family house or to an apartment of a multi dwelling unit (MDU)
- **FTTB** = Fibre to the building

- Fibre extends to a MDU, but not to each floor or apartment.
- **FTTN** = Fibre to the node (e.g. DSLAM)
  - Fibre extends up to about 1500 meters from the premises
  - This covers also the term FTTC (Fibre to the curb)

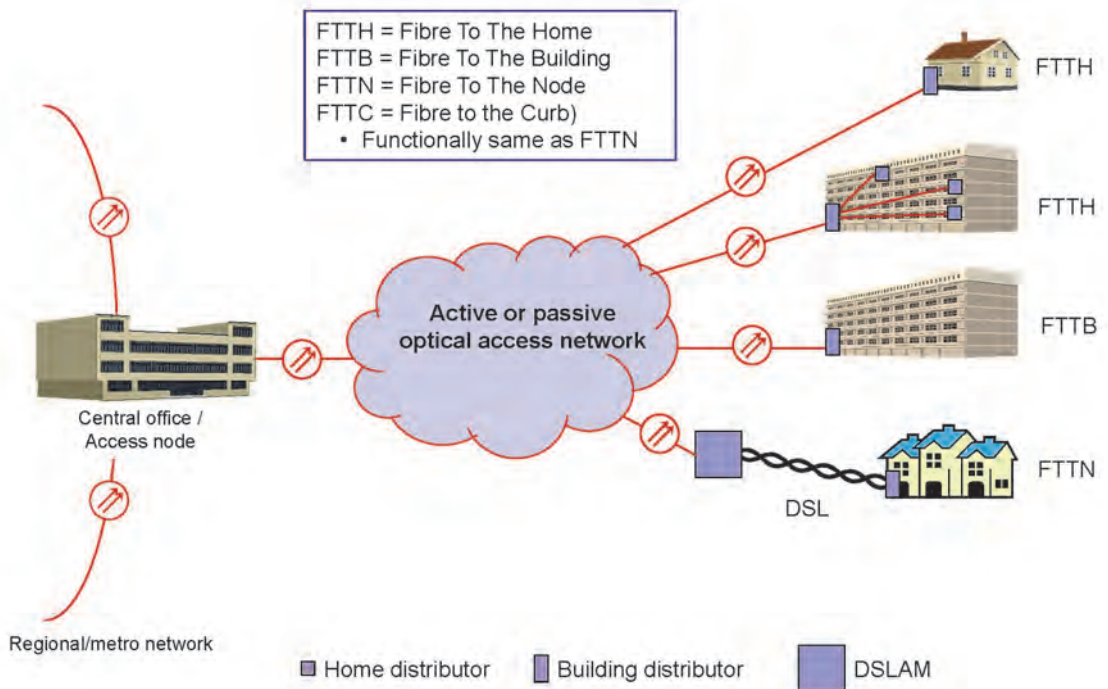

Figure 1.4. Clarification of the most important FTTX concepts.

## 1.3 Optical fibre as a transmission medium

### 1.3.1 Principle of optical transmission in the fibre

In optical transmission the signal is transmitted in a form of light through an optical fibre from the transmitter to the receiver. The function of the transmitter is to convert the electrical signal to be transmitted into the form of light and feed it to the fibre. The receiver receives the light and converts it into a suitable electrical form for further processing of the signal. When the light signal propagates within the fibre, its power decreases more or less depending on the fibre type and the length of the fibre. In other words: the signal is attenuated. In the fibre link there are also fibre splices which cause additional losses. The fibres of the optical fibre cable are terminated to connectors at terminals or distribution frames at both ends of the link. These connectors provide interface to patch cords which are connected to transmitter and receiver. These connections also cause losses. The splices and connections within the link also make a small part of the propagating light reflect back in the return direction. The simplified principle of optical transmission is presented in the figure 1.5.

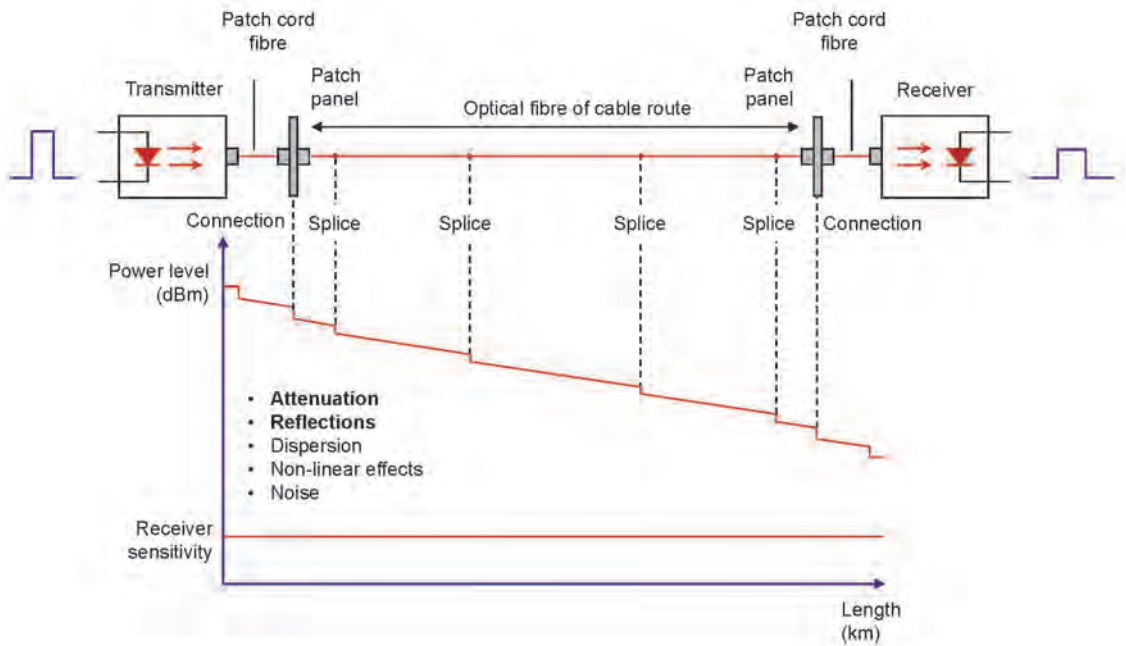

Figure 1.5. The principle of optical transmission.

The total attenuation of the transmission link consists of the fibre attenuation, splice losses and insertion losses of connections. The power level transmitted from the transmitter is decreased in the link by the amount of the total attenuation. This decreased power level shall be high enough in order to be detected in the receiver. Thus the substantial factors for the power budget are: the output power level of the transmitter, the total attenuation of the link and the sensitivity of the receiver. In addition the bandwidth of the link is substantial. The bandwidth expresses the highest frequency to be transmitted, which further determines the highest transmission rate in digital transmission. The bandwidth properties of the fibre are described by terms bandwidth for multimode fibre and dispersion for singlemode fibre. These and other optical characteristics of optical fibres are discussed in chapter 2. The overall channel bandwidth depends also on the characteristics of the transmitter and receiver components.

### 1.3.2 Characteristics and advantages of optical transmission

Optical transmission has superior characteristics compared with electrical transmission due to the transmission technique used and the other properties of the optical fibre cable. These advantages have made the development proceed faster than it was anticipated in the first stage of development. Also some disadvantages are attached to optical fibre cables, but the advantages are significantly greater and more versatile.

The transmission capacity of an optical fibre is extremely high. The highest transmission rate and the longest distance depend on the attenuation and bandwidth of the link and on the characteristics of the transmitter and receiver components. It is possible to implement longer than 100 km link with a singlemode fibre without a repeater and with the transmission rate of several Gbit/s. Low attenuation and broad bandwidth are the superior transmission technical advantages compared with all copper conductor cables and cable systems. The advantage of the low attenuation is emphasized first of all in the long distance network and the broad bandwidth is necessary as the transmission rates are still growing higher in all levels of the networks.



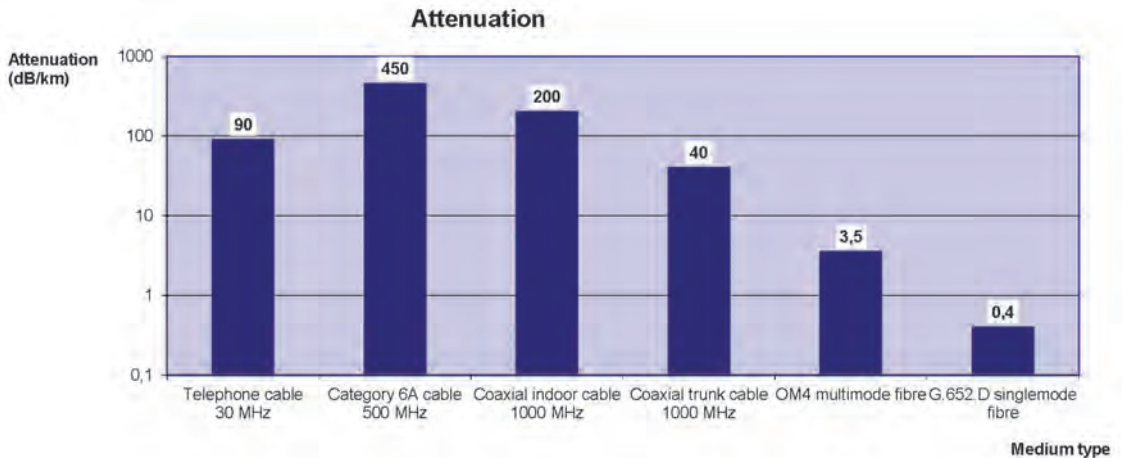

Figure 1.6. Attenuation of singlemode fibre is app. 1000 times less than that of cat 6A copper cable.

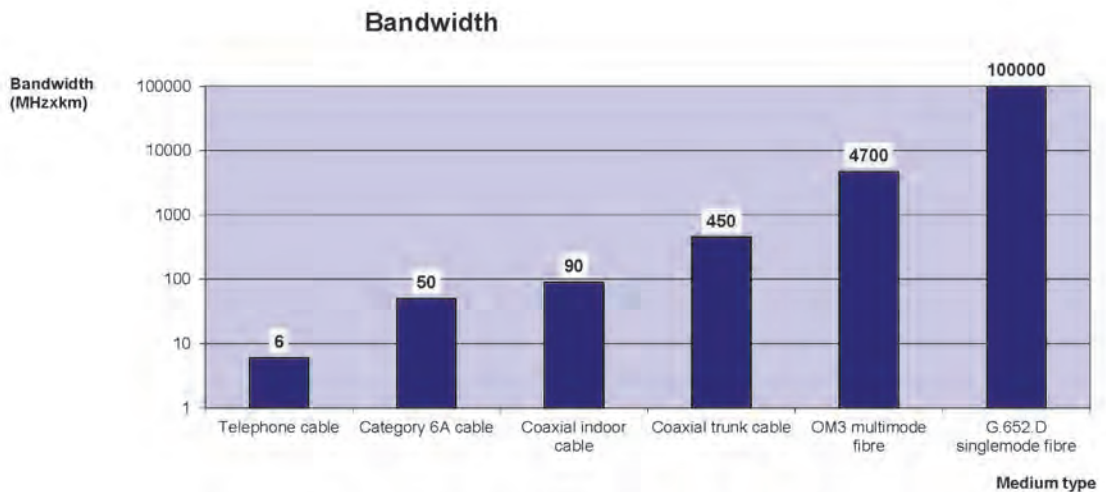

Figure 1.7. Bandwidth of a singlemode fibre (at one wavelength) is app. 2000 times more than that of category 6A copper cable.

The most common fibre material - fused silica glass - is electrically a dielectric. Therefore the optical transmission is free from all kind of electromagnetic interferences. It is immune to electromagnetic interferences and does not emit such interference. No earthing problems exist either, because no galvanic signal connection is needed. The fibre is also immune to overvoltages generated by the electric power network or lightning strikes. Optical fibre cables may, however contain metallic elements, which need relevant electrical protection. Optical fibre is an excellent solution for many transmission applications, where the mentioned things cause problems when using copper cables. Electrically dangerous environments, environments with a danger of explosion and ground wire applications in power lines (OPGW) are some examples of these cases.

The small size and light weight of optical fibres make it possible to design also cable constructions with small size and light weight. This makes handling and installing of cables easy so that for example the delivery and installation lengths can be even 12 km. Thanks to its small size the cable does not occupy a big space in the duct or protective pipe.

Optical transmission systems are economical and reliable. The favourable price development advances the economical use of fibre for fewer and fewer customer per one fibre. From the long



distance network applications the fibre is expanding to access networks and is finally reaching homes and offices. In customer premises cabling systems optical fibres have been used more than 20 years and modern cabling systems support 100 Gbit/s applications. The low number of repeaters and electronics required tends to increase the reliability of the systems. The reliability of transmitter and receiver components is not a problem. Also the data security is excellent in optical systems.

The advantages of optical fibre can be briefly listed as follows:

- Optical fibre can be applied in all levels of networks
- Optical fibre supports all new technologies and services
- Optical fibre adapts easily to increasing need of capacity
- Optical fibre enables implementation of reliable links and networks
- Optical technology is energy efficient and “green”

The small size and the glass material of the fibre also bring about some aspects of caution. Handling of a thin fibre requires precision and care. The glass differs from metals in its material characteristics, because it lacks almost totally elastic properties. The behaviour of glass is, however, known well and no problem will arise if the properties of the glass are taken into account by using suitable protective constructions and by proper handling. In addition to proper mechanical handling of fibres also cleanliness is critical especially in fibre splicing and in optical fibre connectors. In fibre optic installations also some safety aspects should be kept in mind and instructions concerning safety should be followed. These are mainly related to laser radiation and short pieces of fibres, which result from splicing and terminating of fibres.

## 1.4 Standards

### ***Optical fibres and optical fibre cables***

- IEC 60793-2-50: Optical fibres – Part 2-50: Product specifications – Sectional specification for class B single-mode fibres.
- ITU-T Recommendation G.652: Characteristics of a single-mode optical fibre and cable.
- ITU-T Recommendation G.657: Characteristics of a bending loss insensitive single mode optical fibre and cable for the access network.
- IEC 60794-1-2: Optical fibre cables - Part 1-2: Generic specification - Basic optical cable test procedures.
- IEC 60794-2: Optical fibre cables - Part 2: Indoor cables (several parts)
- IEC 60794-3: Optical fibre cables - Part 3: Outdoor cables (several parts)
- IEC 60794-4: Optical fibre cables - Part 4: Aerial optical cables along electrical power lines (several parts)
- IEC 60794-5: Optical fibre cables - Part 5: Microduct cabling for installation by blowing (several parts)

### ***Optical fibre connectors and other passive components***

- IEC 61754-4: Fibre optic connector interfaces - Part 4: Type SC connector family.
- IEC 61754-20: Fibre optic connector interfaces – Part 20: Type LC connector family
- IEC 61753-series: Fibre optic interconnecting devices and passive components performance standard (several parts)
- IEC 61755-series: Fibre optic connector optical interfaces (several parts)
- IEC 61300-2: Fibre optic interconnecting devices and passive components – Basic test and measurement procedures – Part 2: Tests (several parts)....
- IEC 61300-3: Fibre optic interconnecting devices and passive components – Basic test and measurement procedures – Part 3: Examination and measurements (several parts)

- ITU-T Recommendation G.671: Transmission characteristics of optical components and subsystems.

### ***Optical transmission systems***

- IEEE 802.3ah: IEEE Standard for Information technology -Telecommunications and information exchange between systems - Local and metropolitan area networks - Specific requirements. Part 3: Carrier Sense Multiple Access with Collision Detection (CSMA/CD) Access Method and Physical Layer Specifications. Amendment: Media Access Control Parameters, Physical Layers, and Management Parameters for Subscriber Access Networks. This standard specifies Ethernet technologies to be used in access networks (Ethernet in the First Mile, EFM).
- IEEE 802.av: IEEE Standard for Information technology - Telecommunications and information exchange between systems - Local and metropolitan area networks - Specific requirements. Part 3: Carrier Sense Multiple Access with Collision Detection (CSMA/CD) Access Method and Physical Layer Specifications. Amendment: Physical Layer Specifications and Management Parameters for 10 Gb/s Passive Optical Networks.
- ITU-T Recommendation G.694.1: Spectral grids for WDM applications: DWDM frequency grid.
- ITU-T Recommendation G.694.2: Spectral grids for WDM applications: CWDM wavelength grid.
- ITU-T Recommendation G.695: Optical interfaces for coarse wavelength division multiplexing applications.
- ITU-T Recommendation G.984.1: Gigabit-capable passive optical networks (GPON): General characteristics.
- ITU-T Recommendation G.984.2: Gigabit-capable Passive Optical Networks (G-PON): Physical Media Dependent (PMD) layer specification.
- ITU-T Recommendation G.984.3: Gigabit-capable Passive Optical Networks (G-PON): Transmission convergence layer specification.
- ITU-T Recommendation G.984.4: Gigabit-capable passive optical networks (G-PON): ONT management and control interface specification.
- ITU-T Recommendation G.984.5: Gigabit-capable Passive Optical Networks (G-PON): Enhancement band
- ITU-T Recommendation G.984.6: Gigabit-capable passive optical networks (GPON): Reach extension
- ITU-T Recommendation G.984.7: Gigabit-capable passive optical networks (GPON): Long reach.
- ITU-T Recommendation G.985: 100 Mbit/s point-to-point Ethernet based optical access system
- ITU-T Recommendation G.986: 1 Gbit/s point-to-point Ethernet-based optical access system.
- ITU-T Recommendation G.987: 10-Gigabit-capable passive optical network (XG-PON) systems: Definitions, abbreviations, and acronyms.
- ITU-T Recommendation G.987.1: 10-Gigabit-capable passive optical networks (XG-PON): General requirements.
- ITU-T Recommendation G.987.2: 10-Gigabit-capable passive optical networks (XG-PON): Physical media dependent (PMD) layer specification.
- ITU-T Recommendation G.987.3: 10-Gigabit-capable passive optical networks (XG-PON): Transmission convergence (TC) specifications.
- ITU-T Recommendation G.987.4: 10 Gigabit-capable passive optical networks (XG-PON): Reach extension
- ITU-T Recommendation G.988: ONU management and control interface (OMCI) specification.
- ITU-T Recommendation G.989.1: 40-Gigabit-capable passive optical networks (NG-PON2): General requirements.

- IEC 60728-6: Cable networks for television signals, sound signals and interactive services – Part 6: Optical equipment.
- IEC 60728-13: Cable networks for television signals, sound signals and interactive services - Part 13: Optical systems for broadcast signal transmissions.

### ***Implementation of access networks***

- ITU-T: L-series Recommendations (several recommendations on specific topics of implementation and construction of optical access networks).
- CLC/TR 50510: Fibre optic access to end-user - A guideline to building of FTTX fibre optic network.
- EN 50174-3: Information technology - Cabling installation - Part 3: Installation planning and practices outside buildings.
- EN 50700: Information technology - Premises distribution access network (PDAN) cabling to support deployment of optical broadband networks.
- ETSI TS 101 573: Access, Terminals, Transmission and Multiplexing (ATTM); General engineering of optical building cabling.

### ***Measurement and testing of access network***

- IEC 61280-4-2: Fibre optic communication subsystem basic test procedures – Part 4-2: Fibre optic cable plant – Single-mode fibre optic cable plant attenuation.
- IEC TR 62316: Guidance for the interpretation of OTDR backscattering traces.

### ***Customer premises cabling***

- EN 50173-1: Information technology - Generic cabling systems - Part 1: General requirements.
- EN 50173-2: Information technology - Generic cabling systems - Part 2: Office premises.
- EN 50173-3: Information technology - Generic cabling systems - Part 3: Industrial premises.
- EN 50173-4: Information technology - Generic cabling systems - Part 4: Homes.
- EN 50173-5: Information technology - Generic cabling systems - Part 5: Data centres.
- EN 50173-6: Information technology - Generic cabling systems - Part 6: Distributed building services.
- EN 50174-1: Information technology - Cabling installation - Part 1: Installation specification and quality assurance.
- EN 50174-2: Information technology - Cabling installation - Part 2: Installation planning and practices inside buildings.
- EN 50174-3: Information technology - Cabling installation - Part 3: Installation planning and practices outside buildings.
- ISO/IEC 11801: Information technology - Generic cabling for customer premises.
- ISO/IEC 15018: Information technology - Generic cabling for homes.
- ISO/IEC 24702: Information technology - Generic cabling – Industrial premises.
- ISO/IEC 24764: Information technology - Generic cabling for data centers.

## 2 Optical fibres

### 2.1 Light propagation in optical fibre

The function of an optical fibre is based on the laws of refraction and reflection of light at the boundary surface of two media. In figure 2.1 a ray of light arrives to the boundary surface of two media with different refractive indexes. Medium 1 has greater refractive index than medium 2 ( $n_1 > n_2$ ). The ray of light coming from medium 1 arrives to the boundary surface at the angle of incidence of  $\varphi_1$  and it is refracted with the angle of refraction of  $\varphi_2$ . The angle of incidence and the angle of refraction are defined as the angles between ray of light and the normal of the boundary surface. In figure 2.1 the angle of refraction is greater than the angle of incidence. The refraction follows Snell's law of refraction as follows:

$$n_1 \sin\varphi_1 = n_2 \sin\varphi_2$$

When the angle of incidence is increased to a certain value, the ray of light is refracted with the angle of refraction of 90 degrees. In other words it propagates parallel to the boundary surface. When the angle of incidence is still increased, the ray of light is reflected totally back to medium 1 having the angle of refraction equal to the angle of incident. This phenomenon is called total reflection and the angle of incidence at which the total reflection happens is called the critical angle.

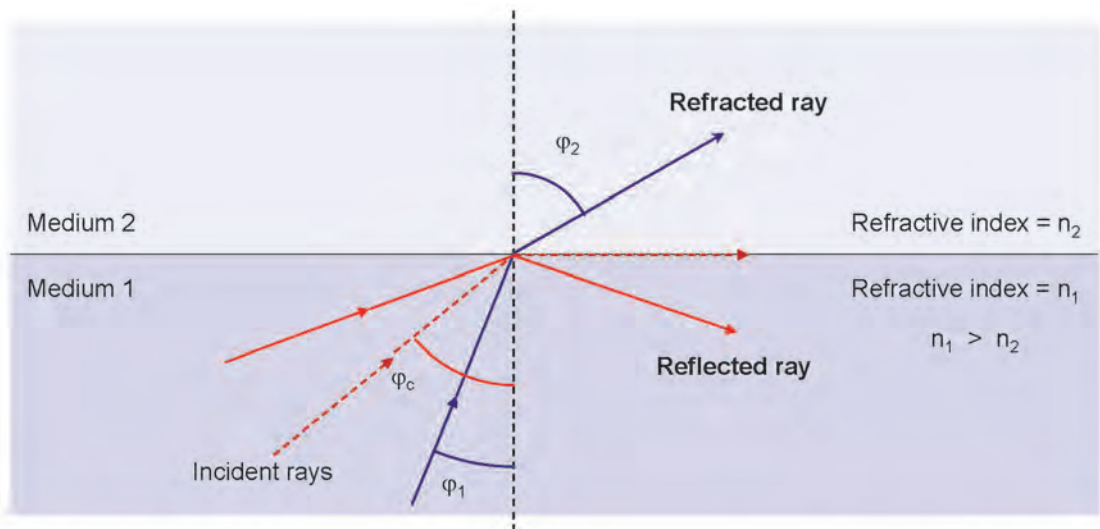

Critical angle  $\varphi_c = \arcsin(n_2/n_1)$   
Then  $\varphi_2 = 90^\circ$

Snell's law:  $n_1 \sin\varphi_1 = n_2 \sin\varphi_2$

Figure 2.1. Snell's law and critical angle.

Figure 2.2 shows principles of cross section and longitudinal section of an optical fibre. An optical fibre consists of two structural elements: core and cladding. The refractive index ( $n_1$ ) of the core is greater than the refractive index ( $n_2$ ) of the cladding. When the angle  $\varphi$  between the entering ray of light and the axis of the fibre is sufficiently small, total reflection happens at the boundary surface between the core and the cladding and the ray of light will be guided in the core. Those rays which are not guided in the core enter through the boundary surface into the cladding.

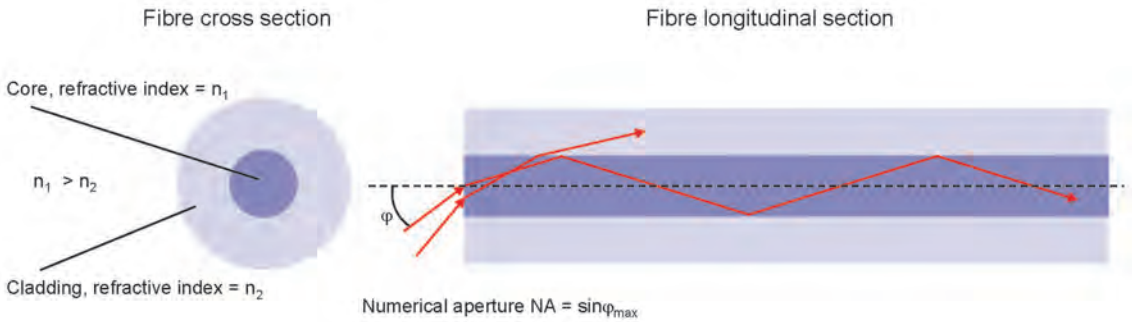

Figure 2.2. Principle of an optical fibre.

The sine function of the greatest allowed angle of incidence  $\varphi$  according to the figure 2.2 is called the numerical aperture, NA:

$$NA = \sin\varphi_{\max}$$

## 2.2 Basic fibre types

The propagation of light in the optical fibre core depends on the refractive index profile of the fibre. Optical fibres are divided into basic types according to their refractive index profile. The main division is made into multimode fibres and singlemode fibres. Both multimode fibres and singlemode fibres can still be subdivided into different types and categories. Figure 2.3 shows the principles of a graded index multimode fibre and a singlemode fibre.

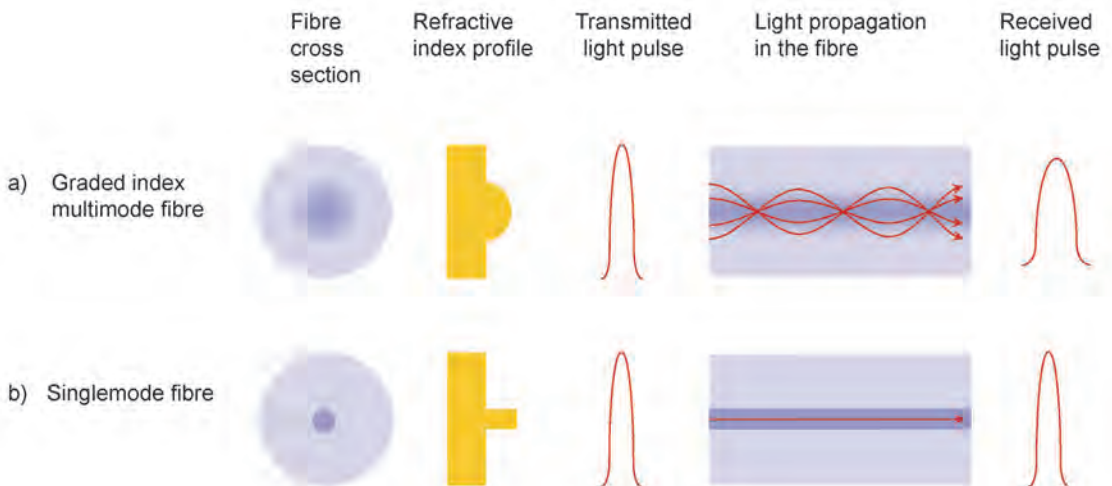

Figure 2.3. Principles of graded index multimode fibre (a) and singlemode fibre (b).

In the graded index multimode fibre the diameter of the core is typically 50  $\mu\text{m}$  or 62,5  $\mu\text{m}$  and the diameter of the cladding is 125  $\mu\text{m}$ . The refractive index in the core is reduced gradually from the centre of the core towards the boundary surface of the core and the cladding. In the graded index multimode fibre there are many propagation paths (propagation modes) in the fibre core, but the paths are smoothly bended, not abruptly reflected. In the centre part of the core the propagation paths are shorter and the velocity of light is lower than in the outer parts of the core, where the propagation paths are longer. By adjusting gradually the refractive index of the multimode fibre the modal dispersion can be reduced and thus the bandwidth of the multimode fibre can be improved.

In a singlemode fibre the diameter of the core is very small and the change of refractive index



is such that only one propagation mode is possible at the operating wavelength. Practically this means core diameter in the order of 8 - 9  $\mu\text{m}$ . In this case no modal dispersion exists, but chromatic dispersion and polarization mode dispersion exist. These phenomena are discussed in clause 2.4. The attenuation of the singlemode fibre is very small compared with that of multimode fibres. In the singlemode fibre a part of the optical power is propagated in cladding and therefore the term mode field diameter is defined. The mode field diameter is the effective diameter of that area in the singlemode fibre, where the optical power propagates.

The size of optical fibre is expressed by using a designation, which indicates the diameter of the core and the cladding in the following form: core diameter/ cladding diameter, e.g. 9/125  $\mu\text{m}$ .

The mechanical characteristics of optical fibres are discussed in clause 2.3 and optical characteristics in clause 2.4.

### 2.2.1 Standardized fibre types

#### **Singlemode fibres according to ITU-T and IEC**

- Singlemode fibre (SM) ITU-T G.652:
  - Type designation SM, dimensions 9/125  $\mu\text{m}$
  - Equivalent to IEC 60793-2-50, B1.1 and B1.3
  - Conventional and the most common fibre type in existing public telecommunications networks
  - Categories A, B, C and D
  - Only category D is recommended for new installations (see next bullet)
- Low water peak (LWP) singlemode fibre ITU-T G.652.D:
  - Maximum attenuation specified also at 1383 nm
  - Equivalent to IEC 60793-2-50, B1.3.
  - More capacity for regional and access networks
  - Supports CWDM (coarse wavelength division multiplexing)
  - Usable wavelengths between 20 nm intervals within the range 1270...1610 nm
- Bending loss insensitive singlemode optical fibre ITU-T G.657
  - Four categories (A1, A2, B2 and B3) with different bending characteristics
  - Equivalent to IEC 60793-2-50, B6\_a1, B6\_a2, B6\_b2 and B6\_b3
  - For access networks and indoor installations
- Non zero dispersion shifted (NZDS) singlemode fibres ITU-T G.655 and ITU-T G.656
  - Support especially DWDM (dense wavelength division multiplexing)
  - High transmission rates, long distances and DWDM
  - Wavelengths with even 0,6 nm intervals
  - Optimized for wavelengths 1530...1565 nm (ITU-T G.655) or 1460...1625 nm (ITU-T G.656)
  - Non-linear phenomena minimized

**Table 2.1.** Correspondence of ITU-T and IEC singlemode fibres.

ITU-T	IEC 60793-2-50
G.652.A/B	B1.1
G.654.B	B1.2_b
G.654.C	B1.2_c
G.652.C/D	B1.3
G.653 A/B	B2
G.655.C	B4_c
G.655.D	B4_d
G.655.E	B4_e
G.656	B5
G.657.A1	B6_a1
G.657.A2	B6_a2
G.657.B2	B6_b2
G.657.B3	B6_b3

Singlemode fibres according to generic cabling standards (EN 50173-1 and ISO/IEC 11801)

- Cabled fibre category OS1
  - IEC 60793-2-50 fibre type B1.3 or B6\_a with max. 1 dB/km attenuation at 1310 nm, 1383 nm and 1550 nm
- Cabled fibre category OS2
  - IEC 60793-2-50 fibre type B1.3 or B6\_a with max. 0,4 dB/km attenuation at 1310 nm, 1383 nm and 1550 nm

**Table 2.2.** Cabled fibre categories OS1 and OS2.

Cabled fibre category	Reference standard	Maximum attenuation, dB/km		
		1310 nm	1383 nm	1550 nm
<b>OS1</b>	IEC/EN 60793-2-50:B1.3 tai B6_a.	1,0	1,0	1,0
<b>OS2</b>	IEC/EN 60793-2-50:B1.3 tai B6_a.	0,4	0,4	0,4

### **Multimode fibres**

- Multimode fibres used in information technology generic cabling according to the standards EN 50173-1 and ISO/IEC 11801:
  - Cabled fibre category OM1, typically 62,5/125 µm
  - Cabled fibre category OM2, typically 50/125 µm
  - Cabled fibre category OM3, always 50/125 µm
  - Cabled fibre category OM4, always 50/125 µm
- Uncategorized 62,5/125 µm multimode fibre, which does not meet the above mentioned standards (these may be found in existing installations which are older than 10 years)
- Other multimode fibres, such as e.g. 100/140 µm (old type, but may be found in existing installations which are older than 12 years)

**Table 2.3.** Cabled fibre categories OM1, OM2, OM3 and OM4.

Cabled fibre category	Reference standard IEC/EN 60793-2-10	Maximum attenuation, dB/km		Minimum bandwidth, MHz x km		
				LED source		Laser source
		850 nm	1300 nm	850 nm	1300 nm	850 nm
<b>OM1</b>	A1b	3,5	1,5	200	500	not specified
<b>OM2</b>	A1a.1	3,5	1,5	500	500	not specified
<b>OM3</b>	A1a.2	3,5	1,5	1500	500	2000
<b>OM4</b>	A1a.3	3,5	1,5	3500	500	4700

### 2.3 Materials and mechanical characteristics of optical fibres

Optical fibres used in the telecommunications are mainly made of fused silica (SiO<sub>2</sub>). In the applications where the low attenuation and the high bandwidth are not required also fibres with glass or plastic core and plastic cladding can be used. In this book only fibres made of fused silica are discussed.

The required refractive index difference between the core and the cladding can be achieved by doping the core material with appropriate doping material, such as germanium oxide (GeO<sub>2</sub>). The typical refractive index in the core (of singlemode fibre) is approx. 1,47 and the refractive index difference is less than 1 %.

The optical fibre is protected with a primary coating, which is applied to the fibre at manufacturing process of the fibre. Typically used material for this is acrylate. The primary coating protects the fibre from scoring and scratching as well as impurities during the fibre handling in the further manufacturing and installation processes. The most common diameter of the primary coating is 250 µm, but also other diameters, such as 200 µm, 400 µm and 500 µm, are possible. The primary coating is coloured for fibre identification. In the cable the coloured primary coated fibres are protected with secondary coating or with other protection methods.

The breaking strength of the optical fibre is great, typically 4...5 GPa. This corresponds to more than 50 N pulling force and the elongation of approximately 5 % with the fibre, which has cladding diameter of 125 µm. The irreversible elongation range of the fibre, however, is very small and therefore the fibre breaks suddenly when the stress is increased. The weak points, such as micro cracks, scores and scratches are critical in the breaking mechanism of the optical fibre. The purpose of the primary coating is just to protect the optical fibre from the factors which cause fatigue. The fatigue will take place when the three following conditions exist at the same time:

- There is a micro crack in the fibre
- The fibre is subject to moisture
- The fibre is subject to long-term tensile stress

During the manufacturing process the optical fibre is proof tested in order to reveal the possible weak points of the fibre. In the proof test the fibre is subject to a certain tensile stress and corresponding strain. The tensile force used in the proof test is clearly smaller than the breaking strength of the fibre but great enough to make the fibre break at the possible weak point. The lifetime of the fibre, which has passed the proof test, can be predicted by using a mathematical lifetime model of the fibre. The prediction is based on the strain used in the test and the maximum strain to be used during operation of the fibre. The strain during the operation generally shall be not more than 1/3 of the strain in the proof test. Generally the proof stress level of 0,69 GPa is

used. The proof test value of 0,69 GPa equals about 1 % strain or about 8,8 N force. Figure 2.4 shows some simplified predicted curves for lifetimes of fibres.

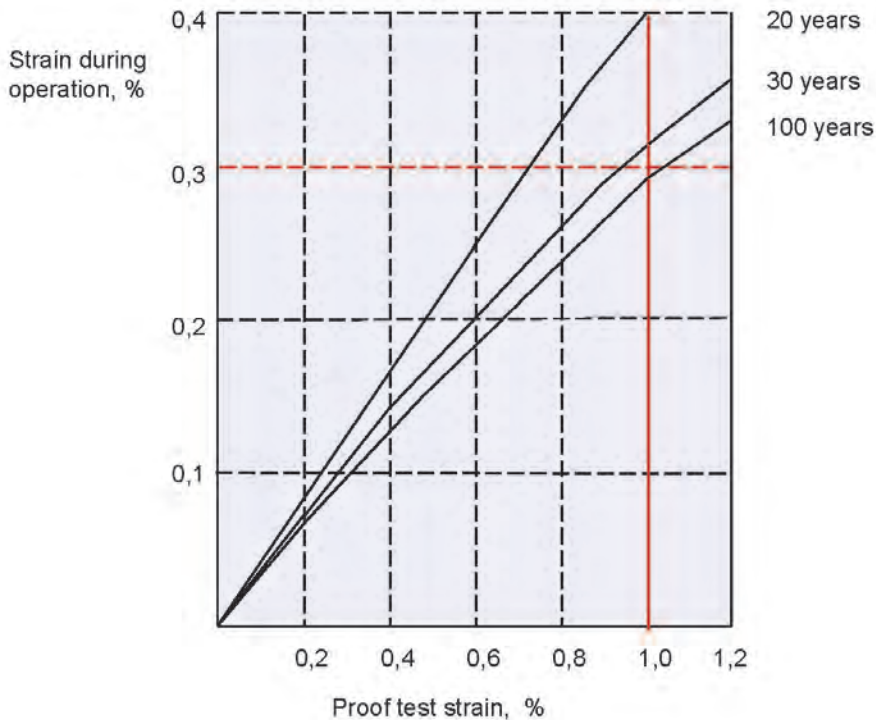

Figure 2.4. Predicted lifetime of fibre as function of proof test strain and operational strain.

It can be seen from the figure 2.4 that a fibre with proof test strain of 1 % has lifetime of more than 30 years, if the maximum strain during operation is 0,3 %.

When bending the fibre it is important to follow the minimum bending radius given for the fibre to avoid extra losses and excessive stress or even break. If the bending radius is great compared with the fibre diameter (more than 1 mm), the bending is called macrobending. When the fibre is pressed e.g. against a rough surface microbending takes place. In microbending the local bending radius is less than 1 mm. The recommended minimum bending radius of the ITU-T G.652.D optical fibre is 30...40 mm. ITU-T Recommendation G.657 and IEC 60794-2-50 specify also bending loss insensitive singlemode optical fibres with smaller bending radius.

The fibre dimensions and their tolerances are specified in standards. Correct dimensions and tolerances are important e.g. for splicing and connecting the fibres. Table 2.4 shows typical values for dimensions and tolerances for optical fibres.

Table 2.4. Typical dimensions and tolerances of optical fibres.

Multimode fibre 50/125 µm (e.g. OM3)		Singlemode fibre 9/125 µm (e.g. 652.D)	
Core diameter	50 ± 2,5 µm	Mode field diameter at 1310 nm	
Core non-circularity	≤ 6 %	- nominal value	8,6... 9,5 µm
		- tolerance	± 0,6 µm
Core non-concentricity	≤ 3 µm	Core non-concentricity	≤ 0,6 µm
Cladding diameter	125 ± 2 µm	Cladding diameter	125 ± 1 µm
Cladding non-circularity	≤ 2 %	Cladding non-circularity	≤ 1 %

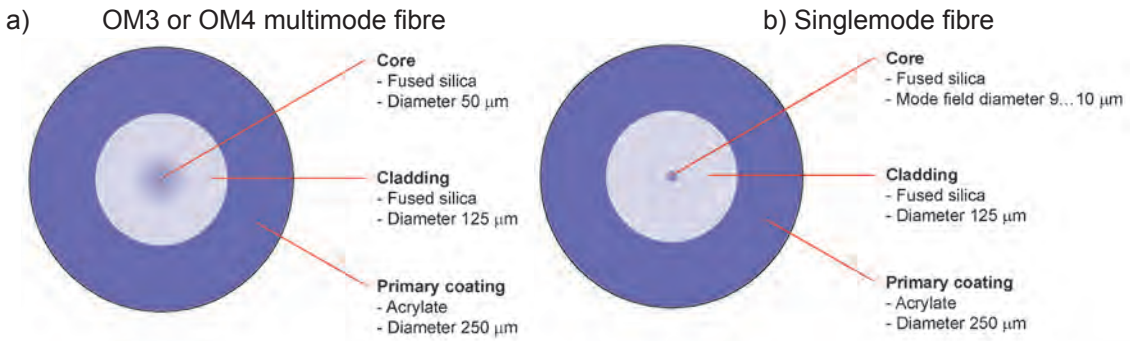

Figure 2.5. Cross sectional profiles of a multimode fibre (a) and a singlemode fibre (b).

## 2.4 Optical characteristics of optical fibres

The most important optical characteristics of optical fibres are the following:

- Attenuation (multimode and singlemode fibres)
- Bandwidth (multimode fibres) or dispersions (singlemode fibres)
- Non-linear effects (singlemode fibres)
- Cut-off wavelength (singlemode fibres)
- Mode field diameter (singlemode fibre)
- Numerical aperture (multimode fibres)

Typical optical characteristics of optical fibres are shown in tables 2.5 (singlemode fibres) and 2.6 (multimode fibres).

Table 2.5. Typical optical characteristics of singlemode fibres.

Fibre type → Characteristics ↓	Singlemode fibre (SM) ITU-T G.652.A	Low water peak (LWP) singlemode fibre ITU-T G.652.D	Bending loss insensitive singlemode fibre ITU-T G.657	
			A1 and A2	B2 and B3
Attenuation, dB/km  1310 nm 1310 ...1625 nm 1550 nm	≤ 0,50	≤ 0,40	≤ 0,40	≤ 0,40
	Unspecified	≤ 0,40	≤ 0,40	≤ 0,40
	≤ 0,40	≤ 0,30	≤ 0,30	≤ 0,30
Chromatic dispersion, ps/ (nm×km)  1310 nm 1550 nm	≤ 3,5	≤ 3,5	≤ 3,5	≤ 4,2
	≤ 17	≤ 17	≤ 17	≤ 20
	≤ 0,5 ps/√km	≤ 0,2 ps/√km	≤ 0,2 ps/√km	≤ 0,5 ps/√km
Polarization mode dispersion (PMD)	≤ 0,5 ps/√km	≤ 0,2 ps/√km	≤ 0,2 ps/√km	≤ 0,5 ps/√km
Cut-off wavelength, nm	≤ 1260	≤ 1260	≤ 1260	

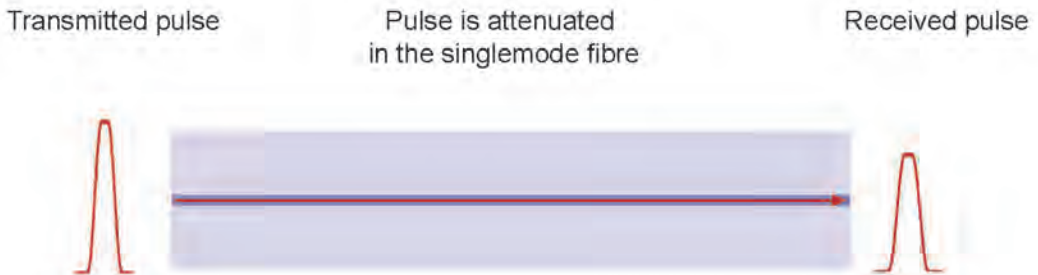

**Table 2.6.** Typical optical characteristics of multimode fibres. Attenuation and bandwidth values are in accordance with the standards EN 50173-1 and ISO/IEC 11801.

Fibre type → Characteristics ↓	OM1 62,5/125 µm	OM2 50/125 µm	OM3 50/125 µm	OM4 50/125 µm
Attenuation, dB/ km 850 nm 1300 nm	≤ 3,5 ≤ 1,5	≤ 3,5 ≤ 1,5	≤ 3,5 ≤ 1,5	≤ 3,5 ≤ 1,5
Bandwidth, MHzxkm 850 nm (LED) 850 nm (Laser) 1300 nm (LED)	≥ 200 Not specified ≥ 500	≥ 500 Not specified ≥ 500	≥ 1500 ≥ 2000 ≥ 500	≥ 3500 ≥ 4700 ≥ 500
Numerical aperture	0,275	0,200	0,200	0,200

### 2.4.1 Attenuation

Attenuation means that the optical power is decreased when the optical signal propagates along the optical fibre. The unit of attenuation is dB/km. The attenuation of the fibre is mainly caused by two factors: absorption and Rayleigh scattering. The absorption in the optical fibre is both intrinsic and extrinsic. The intrinsic absorption consists of infrared (IR) and ultraviolet (UV) absorption and the extrinsic absorption is mainly caused by impurities in the fibre. Among the most significant impurities to cause attenuation are OH<sup>-</sup>-ions. In Rayleigh scattering the small (microscopic) density perturbations in the glass material make the propagating light to be distributed in many directions including the reverse direction. The lowest limit of the attenuation with an absorption free fibre is determined by the Rayleigh scattering and it is approximately 0,16 dB/km at the wavelength of 1550 nm. The attenuation in fused silica glass fibre depends on the wavelength.



*Figure 2.6. Attenuation in a singlemode fibre.*

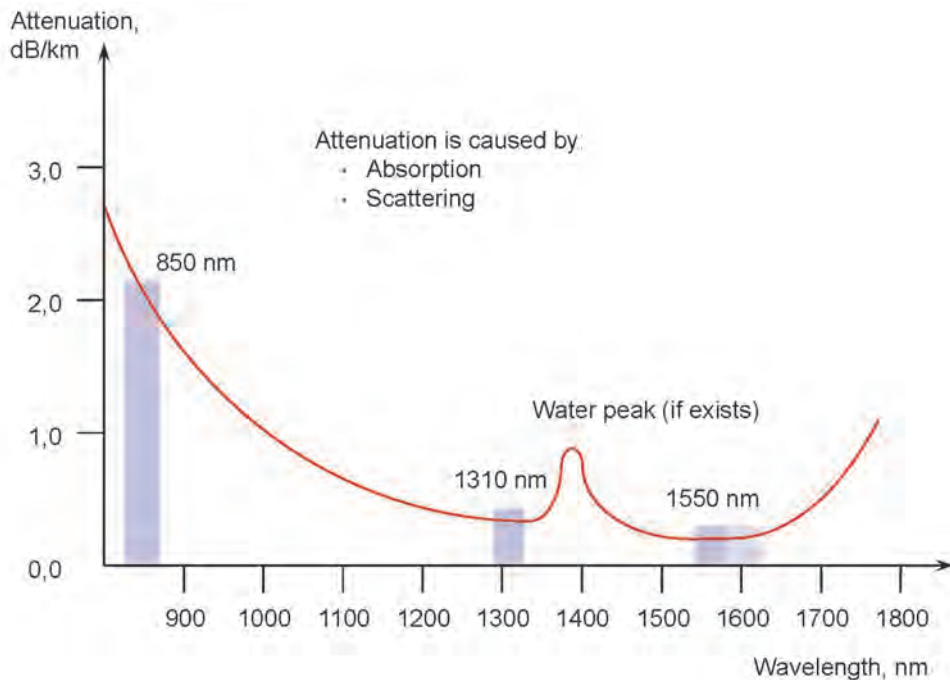

Figure 2.7. Attenuation of fused silica glass fibre and the commonly used wavelength windows.

As can be seen from the figure, the attenuation is smallest in the wavelength range 800...1700 nm. At shorter wavelengths the UV absorption and at longer wavelengths the IR absorption increase the attenuation.

In the telecommunications the three traditional wavelength bands or windows are the following:

- 850 nm window
- 1310 nm window
- 1550 nm window

Multimode fibres are used at 850 nm and 1300 nm windows. Singlemode fibres are used at 1310 nm and 1550 nm windows. The low water peak singlemode fibre (ITU-T G.652.D) allows, however, using also the wavelengths between 1310 nm and 1550 nm. The non-zero dispersion shifted singlemode fibre (ITU-T G.656) allows using the L-band above 1550 nm. This L-band is also shown in figure 2.7. The whole wavelength range used for singlemode fibres is divided even more densely into bands. These bands are shown in figure 2.8 and they are:

- O-band: 1260 ...1360 nm
- E-band: 1360 ...1460 nm
- S-band: 1460 ...1530 nm
- C-band: 1530 ...1565 nm
- L-band: 1565 ...1625 nm
- (U-band: 1625 ...1675 nm)

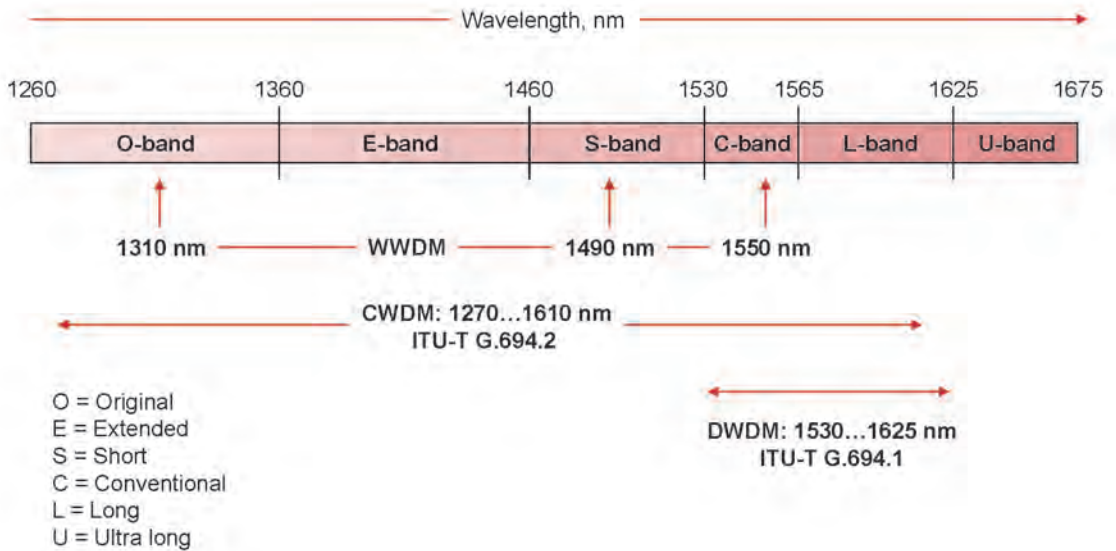

Figure 2.8. The wavelengths and bands of fibre optics and their main applications.

The attenuation peak between 1310 nm and 1550 nm windows is so called water peak caused by the OH<sup>-</sup> ion. With the low water peak singlemode fibre this water peak is so low that the fibre can be used also at the wavelengths where the peak exists. According to Recommendation ITU-T G.652.D the attenuation at the wavelength of 1383 nm shall be equal or lower than the specified attenuation at the wavelength of 1310 nm.

The attenuation curve of the low water peak singlemode fibre (ITU-T G.652.D) is shown in figure 2.9. The bands O, E, S, C and L are also shown in the figure.

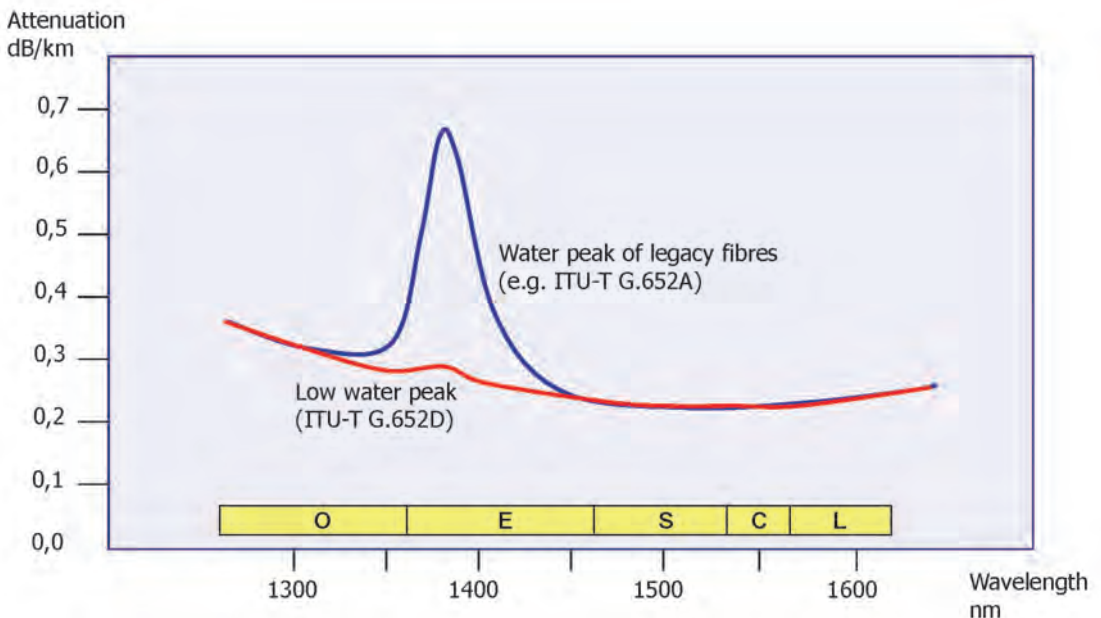

Figure 2.9. The attenuation of the low water peak singlemode fibre (ITU-T G.652.D).

Attenuation in the fibre is also caused by external phenomena, such as macrobending (bending radius  $\gg$  1 mm) and microbending (bending radius  $<$  1 mm) and radioactive radiation. These

factors cause extra attenuation and they should be minimized or totally eliminated with appropriate fibre and cable constructions as well as proper installation methods.

### 2.4.2 Dispersions of singlemode fibre

#### Chromatic dispersion

The most significant type of dispersion in singlemode fibres is the chromatic dispersion. Chromatic dispersion consists of material dispersion and waveguide dispersion. Chromatic dispersion is caused by the fact that the slightly different wavelengths contained by the optical signal have slightly different propagation velocities in the fibre. The unit of chromatic dispersion is ps/(nm•km). The numeric value of chromatic dispersion may be negative or positive. Negative dispersion means that longer wavelengths propagate faster than shorter wavelengths and positive dispersion means opposite to that. The effect of the chromatic dispersion is smaller if the spectrum of the transmitted optical signal is narrower. The chromatic dispersion of the standard singlemode fibre (ITU-T G. 652) has its minimum at the wavelength of approximately 1310 nm. By modifying the refractive index profile the minimum point can be shifted to the 1550 window, where also is the attenuation minimum of fused silica glass fibre. Typical representative of this kind of fibre is non-zero dispersion shifted singlemode fibre specified in ITU-T G.655. Chromatic dispersion is a material property of the fibre and in practice its numerical value does not change during the cable manufacturing and installation processes. Typical values of chromatic dispersion of different singlemode fibres are shown in table 2.3. Chromatic dispersion causes spreading of the light pulses as can be seen in figure 2.10. The effect of attenuation is also shown in the figure.

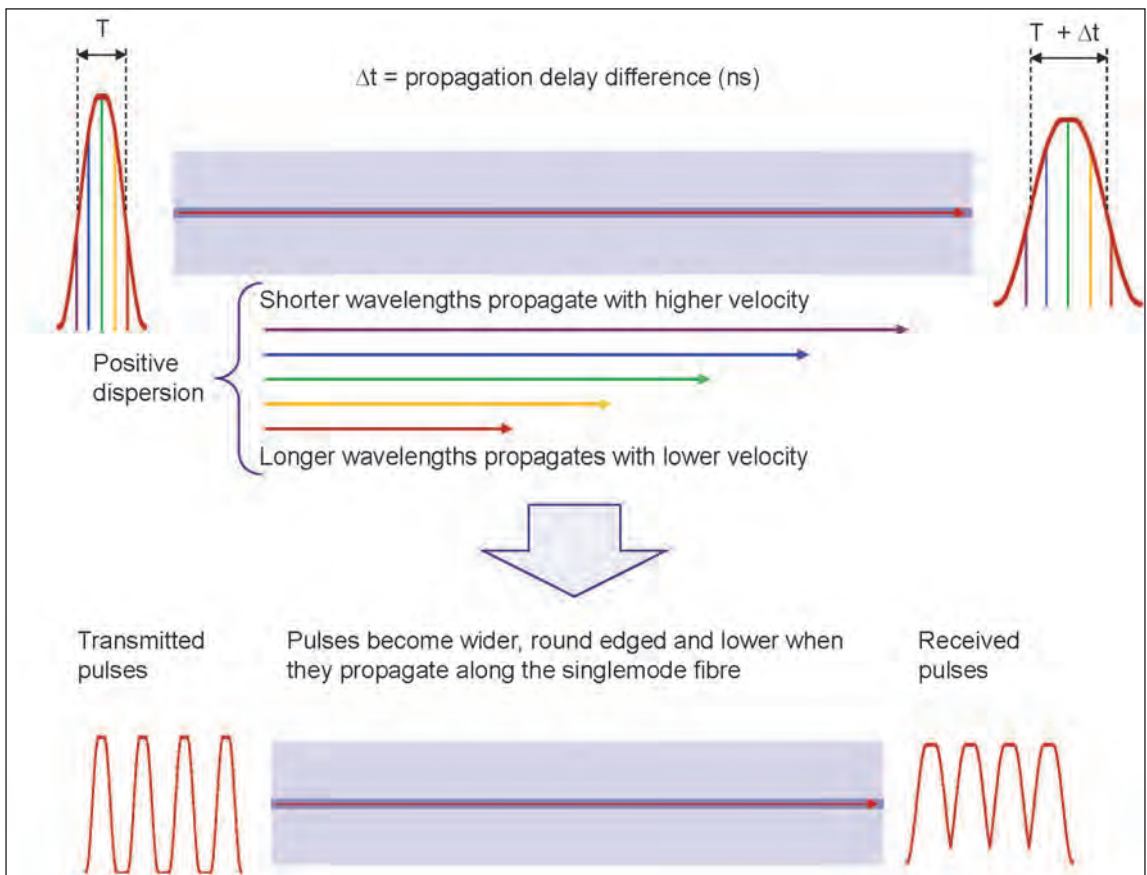

Figure 2.10. Chromatic dispersion causes spreading of the light pulses.

### Polarization mode dispersion (PMD)

In addition to the chromatic dispersion also another form of dispersion appears in the singlemode fibre: polarization mode dispersion (PMD). This type of dispersion is caused by the fact, that the optical signal has two polarization modes in the fibre. The propagation velocities of the two polarization modes are slightly different from each other, which results in a difference between the propagation delays, i.e. the dispersion. Figure 2.11 illustrates this situation. The polarization mode dispersion depends on the geometry and the mechanical stress conditions of the fibre. This means that the cable construction has its effect on the polarization mode dispersion in the cable. The characterization of PMD is very difficult by the statistical nature of the phenomenon. The polarization mode dispersion is typically much smaller than the chromatic dispersion. It has significance in analogue cable television systems and in digital transmission at higher transmission rates, such as 2,5 Gbit/s and higher and when the distance is more than 50 km. Typically the polarization mode dispersion in optical fibre cable is less than 0,2 ps/ $\sqrt{\text{km}}$ .

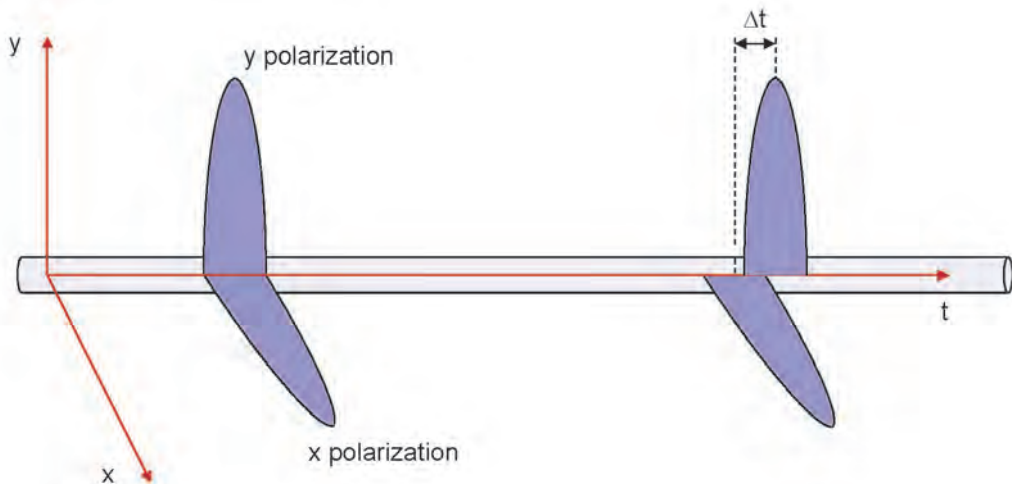

Figure 2.11. The propagation velocities of the two polarization modes ( x and y ) are slightly different from each other, which results in a difference between the propagation delays, i.e. the dispersion.

### 2.4.3 Non-linear effects

When the power level of the optical signal in the singlemode fibre increases the non-linear effects also become significant. Higher power levels appear in long distance transmission, when optical fibre amplifiers are used. By using optical fibre amplifiers at certain intervals very long transmission distances can be achieved. At the same time, however, the non-linear effects should be controlled in order to keep the disturbances within specified limits.

Non-linear effects are caused by the interaction between the light signal and the glass in atomic level. Deeper knowledge of quantum physics is needed to understand these phenomena completely.

The most significant non-linear effects are the following:

- Stimulated Raman Scattering (SRS)
- Stimulated Brillouin Scattering (SBS)
- Four-Wave Mixing (FWM)
- Self-Phase Modulation (SPM)

These effects have significance in dense wavelength division multiplexing (DWDM), where the used operating wavelengths are very close to each other (at 0,8 nm, 0,4 nm, 0,2 nm or even 0,1



nm intervals). E.g. in the case of uncontrolled four-wave mixing "ghost" wavelengths occurring at operating wavelengths may interfere the signal transmission.

Non-linear effects are not manufacturing errors or faults of singlemode fibres. They are caused by the interaction between the light and the medium, i.e. glass and they follow known physical laws. They are generally significant only, if the distance is very long, transmission rate is very high (more than 10 Gbit/s) and the dense wavelength division multiplexing (DWDM) is used. These effects can be taken into account with an appropriate system design.

#### 2.4.4 Cut-off wavelength of singlemode fibre

The cut-off wavelength of the singlemode fibre is the minimum wavelength to be used in the fibre in order to make the fibre operate as a singlemode fibre. If the used wavelength is smaller than the cut-off wavelength, several modes will propagate, i.e. the fibre acts as a multimode fibre. The cut-off wavelength of the singlemode fibre should therefore be clearly smaller than the operating wavelength.

In pigtails and patch cords the cut-off wavelength should be even slightly smaller than in the optical fibre cables. The reason for this is that the cut-off wavelength of a short fibre also depends on the length of the fibre. The lengths of pigtails and patch cords are typically only few meters.

#### 2.4.5 Mode field diameter (MFD)

In the singlemode fibre the main part of the optical power is propagated in core, but a small part of optical power is also propagating in cladding. Therefore the term mode field diameter is defined. The mode field diameter is the effective diameter of that area in the singlemode fibre, where the optical power propagates. The mode field diameter depends on the wavelength and it increases with increasing wavelength. In other words it can be also said that the propagating optical power is more weakly guided by the fibre, when the wavelength increases.

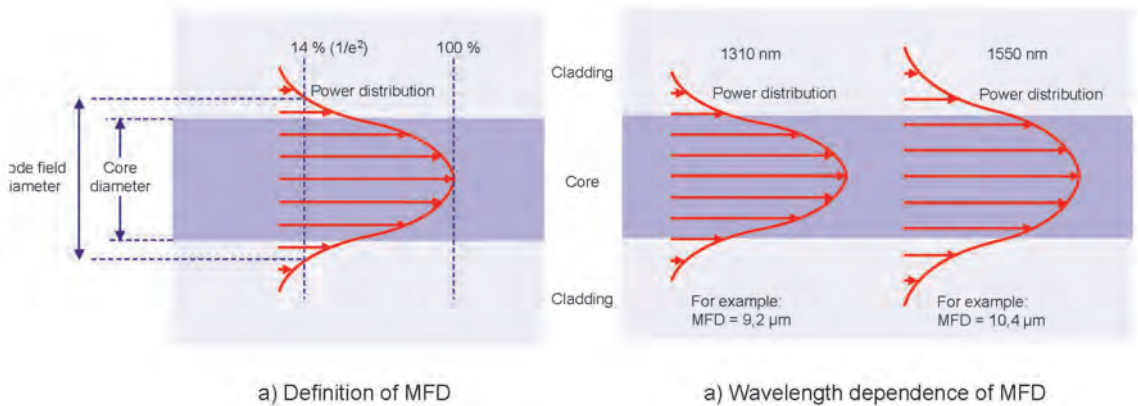

Figure 2.12. Mode field diameter.

#### 2.4.6 Bandwidth of multimode fibre

Bandwidth of the multimode fibre expresses the highest allowed signal frequency to be transmitted in a certain length of the fibre. Bandwidth depends on the wavelength and its unit is MHz·km. For example if the multimode fibre OM1 has the bandwidth of 200 MHz·km at the wavelength of 850 nm, it means that a signal with the highest signal frequency to be transmitted in the length of one kilometre is 200 MHz. If the distance is reduced to half, i.e. 500 m, the highest frequency will be doubled, i.e. it will be increased to 400 MHz. Thus the bandwidth sets a limit for both the transmission rate and the distance. The finite bandwidth of the multimode fibre is due to the modal

dispersion and chromatic dispersion. Laser optimized multimode fibres OM3 and OM4 have higher bandwidth than traditional multimode fibres OM1 and OM2 (see table 2.6). Figure 2.13 illustrates the concept of bandwidth of a multimode fibre as well as the attenuation of a multimode fibre.

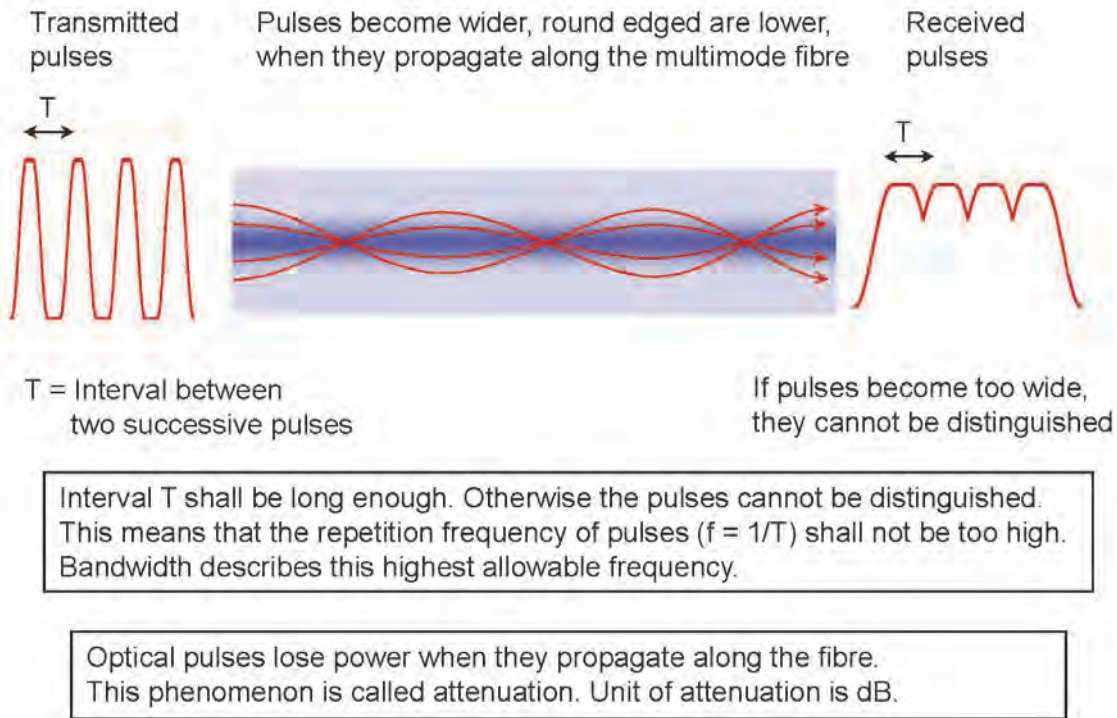

Figure 2.13. Bandwidth of multimode fibre defined.

## 3 Optical fibre cables

### 3.1 Cable constructions

The purpose of the cable construction is to protect the optical fibres from all kinds of stresses during manufacturing, storage, transport, installation and operation. The construction should secure and maintain the transmission characteristics of the optical fibres for the whole estimated lifetime of the cable. This may be 30 years or even more. In addition, the cable construction should be such that the cable is cost effective and easy to install. Also the materials used in the cable should be suitable and compatible with each other. Hence many kinds of requirements must be taken into account in cable design and material choice.

Depending on the installation environment the cables can be divided into two main groups, which are:

- Outdoor cables
- Indoor cables

Outdoor cables can further be divided into four groups depending on the installation method. These groups are:

- Duct cables
  - Conventional duct cables, which can be installed into underground pipes or into duct systems
  - Microduct cables, which are intended to be blown into microduct system.
- Direct burial cables, which can be buried directly underground e.g. by ploughing or into underground pipes or duct systems.
- Aerial cables, which can be installed on poles
- Underwater cables, which can be laid along the bottom of the sea, lake or river.

An optical fibre cable may consist of the following functional elements:

- Fibres and their protective coating
- Cable core construction
- Strength member
- Filling compound or other water blocking material
- Sheath (including possible additional protection)

#### 3.1.1 Fibres and their protection

In the manufacturing stage the fibres are protected with the primary coating. The most common material is acrylate. The primary coating is in tight contact with the fibre and it protects the fibre from scratching and moisture. The primary coating should, however, be easily removable for splicing. Primary coated fibres are coloured for identification purpose. The colour is applied on the surface of the primary coating. The diameter of the coloured primary coated optical fibre is typically 235...265  $\mu\text{m}$ .

Special protection from hydrogen, moisture and fatigue can be achieved with a thin metallic or carbon layer on the cladding. These hermetic and fatigue resistant fibres are used e.g. in deep water submarine cables.

For the further protection secondary coating or some other secondary protection is used for primary coated fibres. The secondary coating (or buffer) may be tight or loose. The tight secondary coating is a single or double polymer layer in tight contact with the primary coating. A typical diameter is 900  $\mu\text{m}$ . The loose secondary coating is in fact a plastic tube containing one or more (up to 24) primary coated fibres. The diameter of the loose tube is 1...3 mm. Tight and loose secondary

coatings are mainly used in stranded cable constructions. A central tube (or unitube) construction is a special case, which combines the functions of the cable core and the secondary coating. Examples of different coating types are shown in figure 3.1.

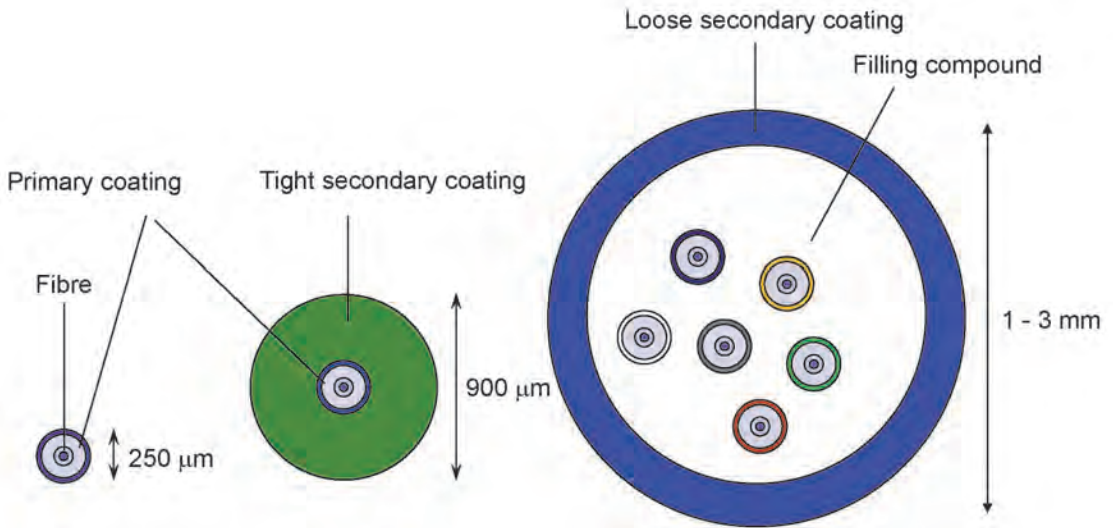

Figure 3.1. Primary coating, tight secondary coating (tight buffer) and loose secondary coating (loose tube).

In a slotted core construction the secondary protection is possible without a tube. Primary coated fibres are located loosely in slots or grooves of the core construction and they are well protected.

In a fibre ribbon the primary coated fibres are located side by side forming a linear array of fibres. The fibres used in the ribbon are normal primary coated fibres with a typical diameter of 250 μm or they may be special fibres with diameter of only 180...200 μm. Such special fibres have a thinner primary coating than the normal fibres. The ribbon construction may be encapsulated, tape supported or edge bonded. One fibre ribbon may consist of 2...24 fibres. An example of an encapsulated fibre ribbon is shown in figure 3.2.

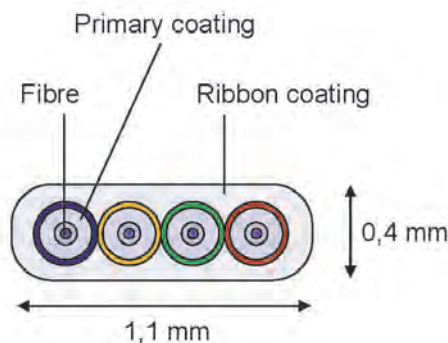

Figure 3.2. Encapsulated fibre ribbon.

### 3.1.2 Cable core constructions

The three traditional basic core constructions of optical fibre cables are:

- Stranded construction
- Central tube construction
- Slotted core construction

In addition to the three above listed traditional basic constructions a new construction, flexible loose tube construction, has recently been developed.

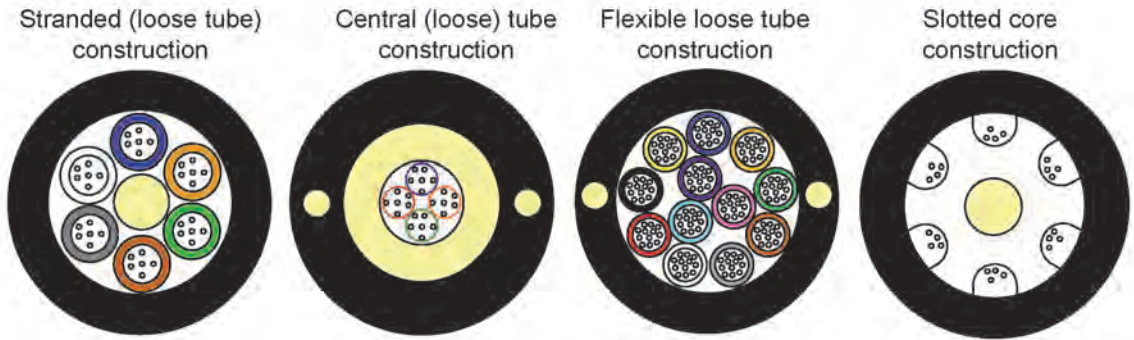

Figure 3.3. Basic core constructions of optical fibre cables.

In the stranded construction secondary coated fibres or fibre bundles are stranded concentrically around the central element. It is common that the stranding changes periodically its direction (SZ). Stranded constructions can be divided into two basic types according to the type of the secondary coating: tight and loose stranded construction. The central element in the stranded construction also has the function of a strength member. The stranded construction represents a traditional and oldest optical fibre cable construction. This optical fibre cable construction is still generally in use.

The central tube construction consists of one plastic tube containing primary coated fibres. The fibres are located loosely within the tube. The diameter of the tube is 5...10 mm. The fibres are grouped into bundles for identification and management of fibres. The central tube construction has very high crush strength. The sufficient tensile strength can be achieved with the strength member layer between the core and the sheath or with metallic or non-metallic wires within the sheath.

The flexible loose tube construction combines the benefits of the stranded loose tube construction and the central loose tube construction. The fibres are within small tubes, which are made of very flexible material. The benefits of flexible loose tubes are very clear compared to the traditional loose tubes. Tubes have small diameter and they have significantly better resistance for kinking than traditional tubes. Stripping of tubes is easy without any tools, cleaning of fibres is also easy as the amount of jelly is minimized and small size of tubes requires less space in closures. All this reduces the work and time needed for cable jointing, splicing and termination and increases the reliability of the network.

The slotted core construction consists of a plastic rod with longitudinal slots (or grooves). The slots pass around the core helically or changing periodically the direction (SZ). Primary coated fibres are located loosely in the slots. The slotted core construction has a very high crush strength and structural clarity for installation. The fibres are easily accessible for splicing and termination. The diameter of the slotted core is 6...12 mm depending on the fibre count. The strength member is located in the central axis of the slotted core.

The core construction of a fibre ribbon cable may be whichever of the above mentioned constructions: stranded, central tube or slotted core. The most common construction is the slotted core construction, because it enables a very high packing density of fibre ribbons, a clear structure and a good protection.

All optical fibre cables on market have a construction based on one of the above mentioned. There are, however, great differences in constructional details, materials and dimensions. Also new cable constructions are being developed continuously. Small sized and economical, but still sufficiently strong and durable cable constructions have been under active development during



recent years. Good examples of these are microduct cables for duct installation and all dielectric self-supporting aerial cables. Also the installation characteristics of optical fibres are under continuous development. As a result of this development are cables with very flexible loose tubes described above.

Figures 3.4....3.10 show examples of these optical fibre cables, which are designed especially for optical access network.

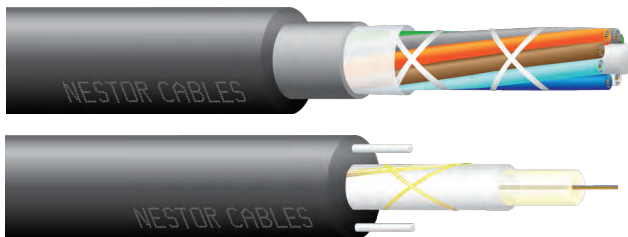

Figure 3.4. Examples of a stranded loose tube cable and a unitube cable for duct installation.

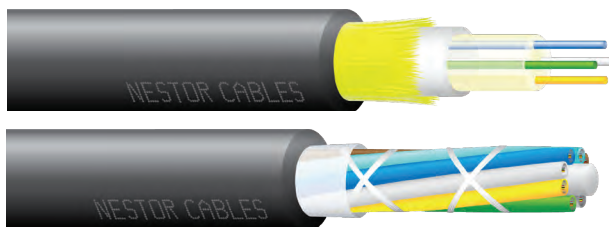

Figure 3.5. Microduct cables.

### 3.1.3 Strength members

The construction of the optical fibre cable shall be such that during installation and operation the fibres are not subject to excessive mechanical stresses, which degrade the transmission characteristics or reduce the lifetime of the fibres. The pulling tension shall not be applied to fibres, but it shall be applied to the strength members of the cable. There are many kinds of strength members depending on the cable construction. The strength and design of a strength member should be such that the fibre strain of 0,3 % is not exceeded during installation and operation, when the cable is installed according to the installation instructions given by its supplier. These instructions should among others give information of the maximum pulling force.

In a stranded and slotted core construction the strength member is generally located in the central axis of the cable. The strength member may be non-metallic or metallic. Non-metallic strength member is often made of fibre reinforced plastic (FRP). FRP strength member gives an excellent tensile strength and enables a light weight cable construction. If further reinforcement is needed, an aramid fibre layer (Kevlar) or glass fibre tapes can be applied between the cable core and the sheath. Metallic strength members may be galvanized or copper clad steel wires.

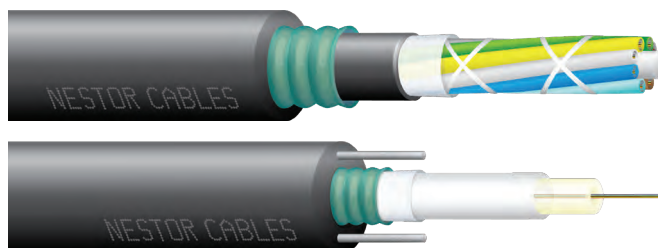

Figure 3.6. Examples of a stranded loose tube cable and a unitube cables for direct burial installation.

In the central tube construction there is no central member. In this case steel wires or FRP wires in the sheath can be used as strength members. Also an aramid fibre layer (Kevlar) or glass fibre tapes can be applied between the cable core and the sheath.

Cables with very flexible loose tubes are also without central member and the strength of the cable shall be achieved by strength members in the sheath.



Figure 3.7. Example of a flexible loose tube cable for direct burial installation.

In an aerial cable the suspension wire has the function of the strength member. The most common cable construction is so called figure eight construction. In this construction the suspension wire is within the cable sheath and it is separated from the cable core with a narrow neck. The strength of the suspension wire is designed to carry also the wind and ice load. Typical suspension wire is a stranded steel wire with its dimensions depending on the required span. During the last ten years also new all-dielectric self-supporting aerial cable constructions have come on market. These small and light weight cables have aramid fibres within the sheath to give the sufficient tensile strength for span lengths even up to several hundred meters.



Figure 3.8. An aerial cable with metallic suspension wire (a) and an all-dielectric self-supporting aerial cable (b)

In underwater cables and when required also in direct burial cables the tensile strength can be increased by applying one or more layers of round wire armouring around the cable (figure 3.9). Typical diameter of armouring wires is 1,0 mm. In direct burial cables the sufficient mechanical strength, however, may often be achieved by using longitudinally overlapped corrugated steel tape armouring over the cable core. In this case the armouring wires are not needed.



Figure 3.9. Round wire armoured underwater cable.

### 3.1.4 Water blocking materials

In outdoor cables the water blocking is very important. The older method for water blocking is using of filling compound, such as jelly or gel. When the cable core is filled with a filling compound water cannot penetrate in the cable core. In the loose stranded construction also the loose tubes are often filled with a filling compound. In a properly filled cable the water can neither enter the cable nor penetrate within the cable.

The newer and also very common method of water blocking is using water swellable tapes or yarns. These materials swell when they get wet and thus they fill all possible water channels within

the cable and fulfil the function of the water blocking material. Water swellable tapes and yarns are easier to handle than jelly or gel. They are commonly used e.g. in indoor/outdoor cables.

In the past also pressurization has been used to protect cables from moisture. This method, however, has become quite obsolete and it not used in new installations.

### 3.1.5 Sheath

The function of the sheath is to support the cable construction and protect the cable core. The sheath of outdoor cables is generally made of polyethylene (PE). Ultraviolet protection can be easily achieved by carbon black in the sheath. The sheath of indoor cables is halogen free, low smoke and flame retardant thermoplastic polymer. In modern cable designs polyvinyl chloride (PVC) is no more used because of its acidity and toxicity and thick smoke generation.



Figure 3.10. Stranded tight buffered indoor cable.

In outdoor cables a moisture barrier in the sheath can be achieved with longitudinally overlapped and laminated aluminium or steel tape. The laminated sheath also gives further mechanical strength. Corrugated steel tape in direct burial cable nowadays mostly replaces the wire armouring. The experience also shows that no metal laminate is needed for moisture barrier function if the cable is provided with a proper filling or with some other water blocking system.

Aerial cables commonly have figure eight construction, where the suspension wire is a part of the sheath construction. There is only a narrow neck between the cable itself and the suspension wire.

Armoured cables have two or more sheaths with armouring wire layers between the sheaths. Underwater cables have same kind of sheath constructions as the wire armoured direct burial cables, but the armouring of underwater cables is generally stronger. Underwater cables should have a strong and durable construction and the cable should follow easily the sea bottom profile.

## 3.2 Differences between outdoor and indoor cables

The environmental and installation conditions inside and outside building differ from each other, and this sets different requirements for the constructions and materials of the cables. It is important to notice the differences between indoor cables and outdoor cables to ensure reliable operation of the cable. In addition to reliability, there are also other factors to be taken into account in cable constructions and materials.

Table 3.1 shows comparison of typical characteristics of indoor and outdoor cables.

**Table 3.1.** Comparison of typical characteristics of indoor and outdoor cables.

Outdoor cables	Indoor cables
Mechanically stronger than corresponding indoor cables. Therefore thicker and more rigid.	More light constructed, more flexible and thinner than corresponding outdoor cables.
The constructions and materials shall withstand the outdoor conditions, such as temperature, moisture, sunlight, etc.	Cable materials and construction shall meet the specified fire safety requirements: flame/ fire retardant, halogen free, low smoke.
Cables shall withstand handling in outdoor conditions.	Cables shall be easy installable to small and narrow spaces.

On market there are also cables, which sufficiently meet the requirements of both indoor and outdoor cables. These so called indoor/outdoor cables are used e.g. in campus and building backbone cabling of generic cabling systems. They can be also used for duct installation provided that the manufacturer's instructions are followed. They should, however, not be used as direct burial cables. Figure 3.11 shows examples of indoor/outdoor cables.

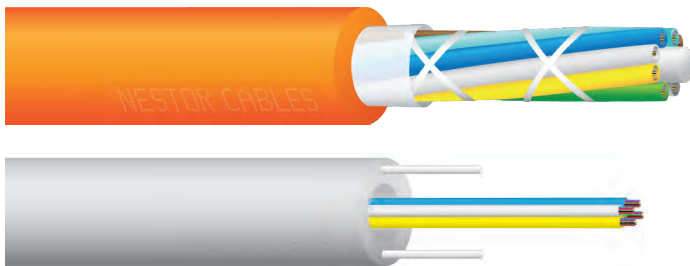

Figure 3.11. Indoor/outdoor cables.

### 3.3 Mechanical and environmental characteristics of cables

An optical fibre cable shall withstand the mechanical and environmental stresses, to which it is subject during installation and use. These stresses and their severity depend on the installation method and environment. Stresses may be mechanical, climatic or other environmental factors. Typical mechanical stresses are e.g. tension, bending, crush and impact. Temperature and moisture are examples of climatic stress factors. In Northern countries there are also some special conditions, which cause stresses. Examples of these are freezing of the ground and water, snow and ice loads and big differences in temperatures in different seasons.

The stresses during installation have generally a short duration, but the severity of the stress during installation may be greater than that during use. The stresses to which the cable is subject during its use affect the cable, however, the whole lifetime of the cable. The specified lifetime of the optical fibre cable is typically 30 years.

Standards specify a great number of characteristics, which describe the ability of the cable to withstand mechanical and environmental stresses. The most important of these are the following:

- Tension
- Crush
- Impact
- Bending
- Temperature cycling
- Water penetration

The ability of the cable to withstand the stresses related to the above listed factors above listed stresses can be tested with methods specified in standards. The international standard to be applied is IEC 60794-1-2: Optical fibre cables – Part 1-2: Generic specification – Basic optical cable test procedures. (This standard has also been approved as a European standard EN 60794-1-2). The standard IEC 60794-1-2 only specifies the basic test procedures. Therefore for each test to be performed also the severity of stress (e.g. tensile force, crush force) and acceptance criteria (e.g. no mechanical damage, no change in attenuation) shall be specified. These are specified in product standards or in other specifications.

Note: Standard IEC 60794-1-2 is being updated at the time of writing this text (6/2014) and it is divided into four parts: IEC 60794-1-21...24. Parts 22, 23 and 24 have already been approved and

published, but part 21 (mechanical tests) is still under preparation.

### 3.3.1 Tensile performance

An optical fibre cable is subject to tensile forces during installation and use. The factors that cause tensile stresses are e.g. the following:

- Pulling during installation
- The effect of freezing ground on the underground cable
- The effect of freezing water on the cable in a pipe or a duct
- Snow, wind and ice loads of the aerial cable

The tensile performance of an optical fibre cable can be tested in accordance with the method E1 specified in the standard IEC 60974-1-2. Recommended minimum values of tensile performance are given in table 3.2.

**Table 3.2.** Recommended minimum values of tensile performance for different cable types.

Cable type	Maximum allowed pulling force, N	Acceptance criteria
Duct cable	≥ 1500 or the weight of the cable per kilometre (whichever is greater)	Fibre strain ≤ 0,33 % (1/3 of the proof test strain). Change of attenuation during test ≤ 0,05 dB
Direct burial cable	≥ 3500	
Aerial cable	≥ 7000	

The values of table 3.2 are general recommendations. Depending on case and conditions greater values may be needed or smaller values may be allowed.

### 3.3.2 Crush

An optical fibre cable may be subject to crushing e.g. in the following situations:

- Direct burial installation (e.g. ploughing)
- The effect of freezing ground on the underground cable
- The effect of freezing water on the cable in a pipe or a duct

The ability of an optical fibre cable to withstand crushing can be tested with the method E3 specified in the standard IEC 60974-1-2. Recommended minimum values of crush strength are given in table 3.3.

**Table 3.3.** Recommended minimum values of crush strength for different cable types.

Cable type	Crush force	Acceptance criteria
Duct cable	Plate: ≥ 3000 N/100 mm Mandrel: ≥ 1000 N/25 mm	No mechanical damage. Change of attenuation during test ≤ 0,05 dB
Direct burial cable	Plate: ≥ 5000 N/100 mm Mandrel: ≥ 2000 N/25 mm	
Aerial cable	Plate: ≥ 2000 N/100 mm Mandrel: ≥ 1000 N/25 mm	

The values of table 3.3 are general recommendations. Depending on case and conditions greater values may be needed or smaller values may be allowed.



### 3.3.3 Impact

An optical fibre cable may be subject to impacts e.g. during installation. Falling stone some other object is a typical example of this.

The ability of an optical fibre cable to withstand impact can be tested with the method E4 specified in the standard IEC 60974-1-2. Recommended minimum values of impact strength are given in table 3.4.

**Table 3.4.** Recommended minimum values of impact strength for different cable types.

Cable type	Impact energy / diameter of striking head	Acceptance criteria
Duct cable	$\geq 15 \text{ J} / 50 \text{ mm}$	No mechanical damage. Change of attenuation during test $\leq 0,05 \text{ dB}$
Direct burial cable	$\geq 30 \text{ J} / 50 \text{ mm}$	
Aerial cable	$\geq 25 \text{ J} / 50 \text{ mm}$	

The values of table 3.4 are general recommendations. Depending on case and conditions greater values may be needed or smaller values may be allowed.

### 3.3.4 Bending

An optical fibre cable is subject to bending during installation and use. During installation the cable often is simultaneously subject to bending and tension. During use the bending stress in duct and direct buried cables is mostly static. For aerial cables, however, the wind causes simultaneous bending and tensile stress.

Standard IEC 60794-1-2 specifies several different bending test methods to be chosen for different purposes. The most generally used bend test methods are method E6 for repeated bending, E11 for bending around mandrel and E18 for bending under tension.

The bending radius of an optical fibre cable should be such that installation of cable is easy and free of damage risks. Too sharp bending may cause sheath break and cable kink. Excessive bending causes excess loss for fibres and in worst case even breaking of fibres. The minimum bending radius is usually given for two situations:

- Bending radius during pulling (when the cable is at the same time subject to pulling and bending)
- Bending radius In final bending (installed position when pulling force is released)

The minimum bending radius in final bending is smaller than during pulling. The limiting values depend on the cable construction and they are given by the manufacturer for each cable type. Typical minimum values for optical fibre cables are:

- During pulling:  $20...30 \times D$
- Final bending:  $15 \times D$

where D is the diameter of the cable.

The minimum bending radius of an optical fibre is  $30...40 \text{ mm}$ .

### 3.3.5 Temperature cycling

The stability behaviour of the attenuation of optical fibre cables submitted to temperature changes can be tested with the temperature cycling test method F1 specified in the standard IEC 60794-1-2. In this test the cable drum is placed in a climatic chamber of suitable size and the temperature inside the chamber is changed in cycles according to specified program. During the test the attenuation of the fibre is measured.

In the Northern countries the outdoor cables should meet the following temperature cycling requirements:

- Temperature range, within which no change of attenuation ( $\leq 0,05$  dB):  $-30\dots+60$  °C
- Temperature range, where change of attenuation (only) during test  $\leq 0,10$  dB/km:  $-45\dots-30$  °C

### 3.3.6 Water penetration

The water tightness of cables with water blocking (jelly, gel or water swellable material) can be tested with the water penetration test method F5 specified in the standard IEC 60794-1-2. In the test a cable sample with length of 3 m is supported horizontally and a 1 m high water column is applied to the core at the open end of the sample. The sample passes the test, if no water is to be seen at the other end of the cable sample during 24 hours.

### 3.3.7 Fire safety of indoor cables

Fire safety has become more and more important aspect in cabling. Cabling installation shall not degrade the fire safety of the building. Both cable choice and way of installation affect the fire safety.

The fire safety aspects related to cable constructions and materials are:

- Flame spread in cable
- Smoke production of the burning cable
- Acidity (and corrosivity) of the smoke gases produced by the burning cable

Fire safe cables are flame retardant or fire retardant (FR), halogen free (HF) and low smoke (LS) cables. Table 3.5 summarises the most important aspects in the fire performance of cables according to IEC and EN standards.

**Table 3.5.** Fire safety characteristics of indoor cables.

Characteristics	Test standard and criteria	
	IEC	EN (CENELEC)
Flame retardant (single cable)	IEC 60332-1	EN 60332-1
Fire retardant (bunched cables)	IEC 60332-3	EN 60332-3
Fire resistant	IEC 60331	EN 50200, EN 50362
Low smoke	IEC 61034 60 % transmission of light	EN 61034 min. 60 % transmission of light
Halogen free, zero halogen, non corrosive	IEC 60754-1 Halogen content: max. 5 mg/g	50267 Halogen content: max. 5 mg/g
Acidity of combustion gases	IEC 60754-2 pH: min. 4,5 Conductivity: max. $\mu 10$ S/m	50267 pH: min. 4,5 Conductivity: max. $\mu 10$ S/m

The fire performance of the cable is generally expressed by using combinations of letters to designate the fire characteristics. There is no standardized designation principle, but the following designations are widely used:

- FRNC      Flame Retardant, Non Corrosive
- LS0H      Low Smoke, Zero Halogen

LSZH	Low Smoke, Zero Halogen
HFFR	Halogen Free, Flame Retardant
FRZH	Flame Retardant, Zero Halogen
LSFRZH	Low Smoke, Flame Retardant, Zero Halogen

Within European Union the new Construction Products Regulation (CPR) will cause changes to the fire safety classification and requirements. With the CPR the following standards will be used:

- EN ISO 1716: Reaction to fire tests for building products - Determination of the heat of combustion.
- EN 50267-2-3: Common test methods for cables under fire conditions - Tests on gases evolved during combustion of material from cables - Part 2-3: Procedures - Determination of degree of acidity of gases for cables by determination of the weighted average of pH and conductivity.
- EN 50399: Common test methods for cables under fire conditions - Heat release and smoke production measurement on cables during flame spread test - Test apparatus, procedures, results.
- EN 60332-1-2: Tests on electric and optical fibre cables under fire conditions – Part 1-2: Test for vertical flame propagation for a single insulated wire or cable – Procedure for 1,0 kW pre-mixed flame.
- EN 61034-2: Measurement of smoke density of cables burning under defined conditions – Part 2: Test procedure and requirements.

### 3.4 Colour coding of fibres

Many various colour coding systems are used for fibre identification. The most widely known and maybe most generally used colour coding system in the world is the colour system specified in US standard ANSI/TIA/EIA 598-C. This colour coding system is shown in table 3.6.

**Table 3.6.** Colour coding of optical fibres according to ANSI/TIA/EIA 598-C.

Fibre number	Colour	Fibre number	Colour
1	blue (BL)	13	blue (BL) with black tracer
2	orange (OR)	14	orange (OR) with black tracer
3	green (GR)	15	green (GR) with black tracer
4	brown (BR)	16	brown (BR) with black tracer
5	slate (SL)	17	slate (SL) with black tracer
6	white (WH)	18	white (WH) with black tracer
7	red (RD)	19	red (RD) with black tracer
8	black (BK)	20	black (BK) with white tracer
9	yellow (YL)	21	yellow (YL) with black tracer
10	violet (VI)	22	violet (VI) with black tracer
11	rose (RS)	23	rose (RS) with black tracer
12	aqua (AQ)	24	aqua (AQ) with black tracer

A colour coding system is also specified in IEC/EN 60794-2. This colour coding system is shown in table 3.7.

**Table 3.7.** Optical fibre colour coding system of IEC/EN 60794-2.

<b>Fibre number</b>	<b>Colour</b>
1	blue (BU)
2	yellow (YE)
3	red (RD)
4	white (WH)
5	green (GN)
6	violet (VT)
7	orange (OG)
8	grey (GY)
9	turquoise (TQ)
10	black (BK)
11	brown (BN)
12	pink (PK)

Many countries have their own national colour coding system. The Finnish national colour coding systems are shown in tables 3.8 (older) and 3.9 (newer). The newer colour coding system shown in table 3.9 is designated as FIN2012.

**Table 3.8.** Older Finnish national colour coding system.

<b>Fibre number</b>	<b>Colour</b>
First fibre	blue (BU)
2., 6., 10., etc. fibre	white (WH)
3., 7., 11., etc. fibre	yellow (YE)
4., 8., 12., etc. fibre	green (GN)
5., 9., 13., etc. fibre	grey (GY)
last fibre	red (RD)

**Table 3.9.** Newer Finnish national colour coding system; FIN 2012.

<b>Fibre number</b>	<b>Colour</b>
1.	blue (BU)
2.	white (WH)
3.	yellow (YE)
4.	green (GN)
5.	grey (GY)
6.	orange (OG)
7.	brown (BN)
8.	turquoise (TQ)
9.	black (BK)
10.	violet (VT)
11.	pink (PK)
12.	red (RD)

The color coding system of optical fibre patch cords are shown in table 3.10. The colour coding system of table 3.10 is based on ANSI/TIA 598-C.

**Table 3.10.** The color coding system of optical fibre patch cord (ANSI/TIA 598-C).

<b>Fibre type</b>	<b>Colour of patch cord sheath (jacket)</b>
Singlemode fibre	yellow (YE)
Multimode fibre 62,5/125 µm	orange (OR)
Multimode fibre 50/125 µm	orange (OR)
Multimode fibre 50/125 µm	aqua (AQ)



## 4 Optical fibre connecting hardware, other passive components and mechanical constructions

### 4.1 Optical fibre connectors

#### 4.1.1 Characteristics of connectors

Optical fibre connectors are used in situations where the connection must be opened and closed repeatedly. Patch panels, optical distribution frames, active transmission equipment, measuring and test equipment and portable systems are examples of these situations.

An optical fibre connector always is more or less a discontinuity in the transmission path and therefore it is often a possible fault point. Therefore the right choice and proper handling of an optical fibre connector are very important for the reliable operation of the network. The optical performance of an optical fibre connector is never as good as that of a fusion splice, but sufficient performance can be achieved by using a proper connector.

A good quality optical fibre connector has the following characteristics:

- Low insertion loss
- High optical return loss
- Good stability of connection
- Good repeatability of connections

Insertion loss is the optical power loss of the connection point. This loss or attenuation should be as small as possible. Many factors affect the insertion loss. Such factors are the quality of ferrule end polishing, alignment accuracy, geometry of fibres and cleanliness. With good quality optical fibre connectors insertion loss of less than 0,3 dB can typically be achieved.

Return loss, more precisely expressed optical return loss (ORL) is the measure of the optical power which is reflected back in the connector interface. This quantity is expressed in decibels (dB). Reflection is an unwanted phenomenon and therefore a higher value of optical return loss represents also a better quality. Such factors as the quality of ferrule end polishing and cleanliness affect the return loss. The minimum return loss value required in most common telecommunications applications is 45 dB. Too low return loss may result in transmission errors. The reflected optical signal may be reflected once more in the forward direction and thus produce unwanted “ghost signals” which disturb the wanted signal. The reflected signal may also cause disturbances in certain types of laser transmitters. Therefore in some applications (e.g. cable television) return loss values of not less than 60 dB may be required. Figure 4.1 illustrates the concepts of insertion loss and return loss.

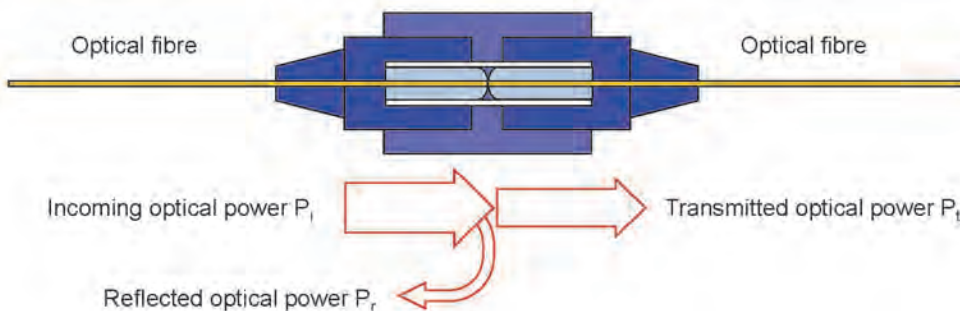

$$\text{Insertion loss IL} = 10 \lg (P_i / P_t) \text{ dB}$$
$$\text{Optical return loss RL} = 10 \lg (P_i / P_r) \text{ dB}$$

Figure 4.1. Insertion loss and return loss.

Good stability means that the specified values of insertion loss and return loss are being maintained during long time in the operation conditions for example within a certain range of temperature. Stability depends on the structural and material characteristics of the connector and the adapter. Repeatability means that the connection can be opened and closed sufficiently many times (typically 500 times) without an essential change in insertion loss and return loss.

The reliability of the connection also requires that the fibre or single fibre cable can be attached to the connector in such a way that the insertion loss is not increased or the connection is not opened when the fibre or cable is pulled with a specified force.

An optical fibre connection consists of two connectors and an adapter. The adapter is used to align the connectors to each other and to protect the connection. A stable connection is achieved by the locking mechanism of the connectors. The performance and quality of a connection thus depend on all these factors – not only on the connectors, but also the adapter.

The most common basic structure of an optical fibre connector is so called ferrule connector. In this kind of connector the fibre end is fixed inside a ferrule by using adhesive. An optical fibre connection is achieved by aligning two ferrules with fibres precisely to each other and by locking the connection. The alignment is made by using an adapter with an alignment sleeve inside. This alignment sleeve guides the ferrule ends towards each other. The principle is shown in figure 4.2. All the most common connector types such as SC and LC are based on ferrule alignment.

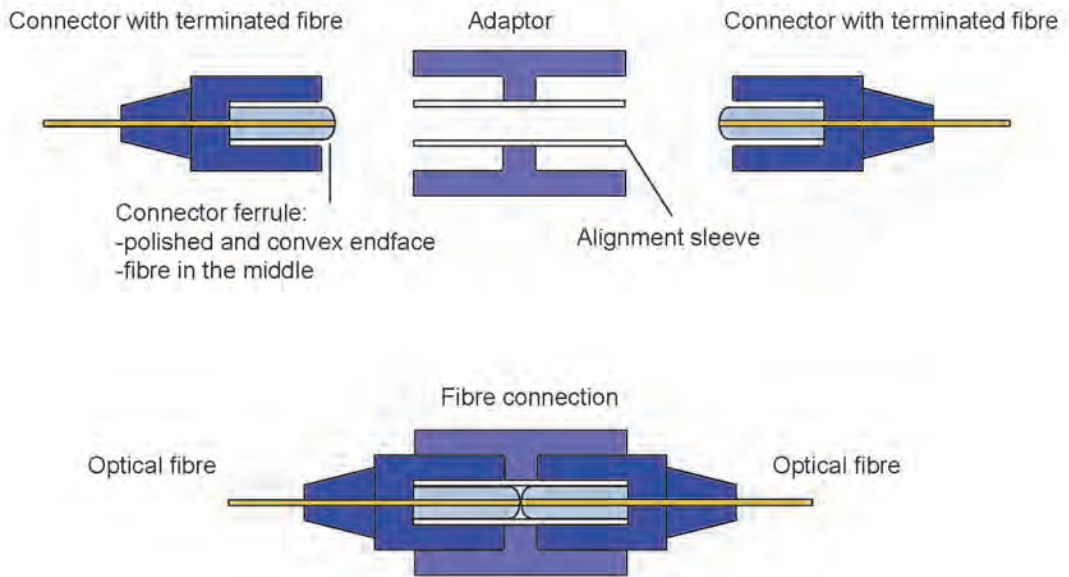

Figure 4.2. Principle of ferrule connector.

In order to enable a reliable connection the ferrule end shall have a little bit convex form. This ensures a physical contact between the fibres in the centre parts of the ferrules and no air gap is left between them. The required shape of ferrule end is made by polishing and the method is called PC polishing (PC = Physical Contact). The most common ferrule material is full ceramic. In multimode technology also plastic and steel ferrules are used in some amount. Full ceramic (e.g. zirconium oxide) ferrules, however, are recommended, because their mechanical and polishing characteristics are better than with other ferrule materials.

The optical return loss characteristics of the connector are determined by the polishing of the ferrule end. The following grades of polishing are widely known:

- PC polishing. This so called ordinary PC polishing was in the past the most common grade of polishing. The achievable typical return loss  $\geq 30$  dB. This grade is no more satisfactory.

- Super PC polishing or SPC. In SPC polishing the better quality is achieved by several polishing phases. The achievable typical return loss  $\geq 40$  dB.
- Ultra PC polishing or UPC. In UPC polishing the last polishing phase is more demanding than in SPC polishing. The achievable typical return loss  $\geq 50$  dB. UPC has been during the last 15 years the most common requirement for modern singlemode technology.
- Angled PC polishing (APC) or slant PC. The ferrule end face is polished at a slight angle (typically 8 degrees). This gives the achievable return loss  $\geq 60$  dB. It is important to notice and understand that APC gives a great ( $> 55$  dB) return loss also when the connector is unmated, while UPC gives only 14 dB return loss in unmated state.

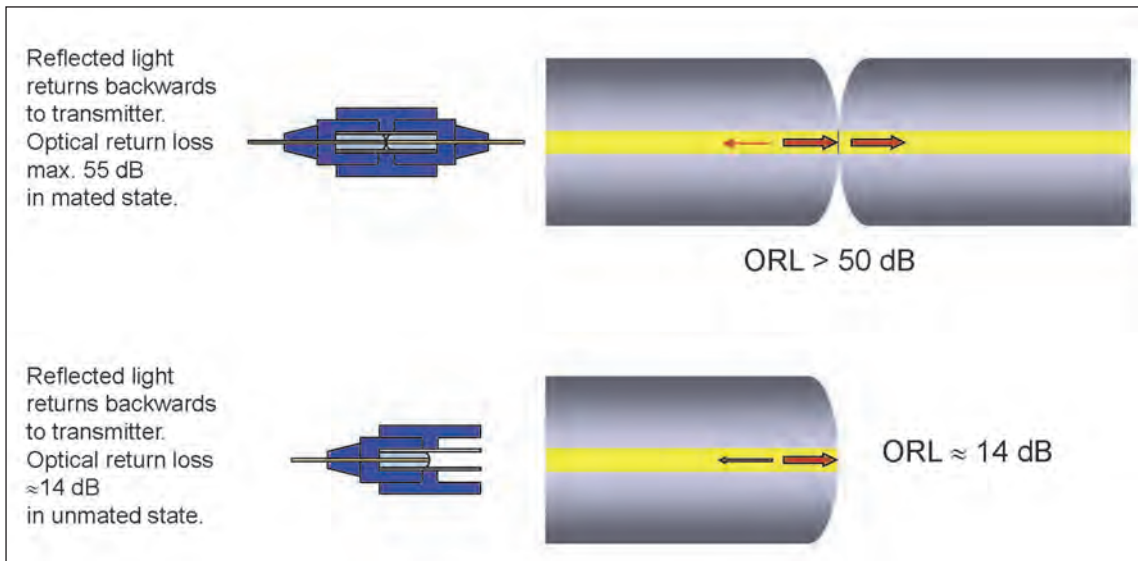

**a) UPC connector**

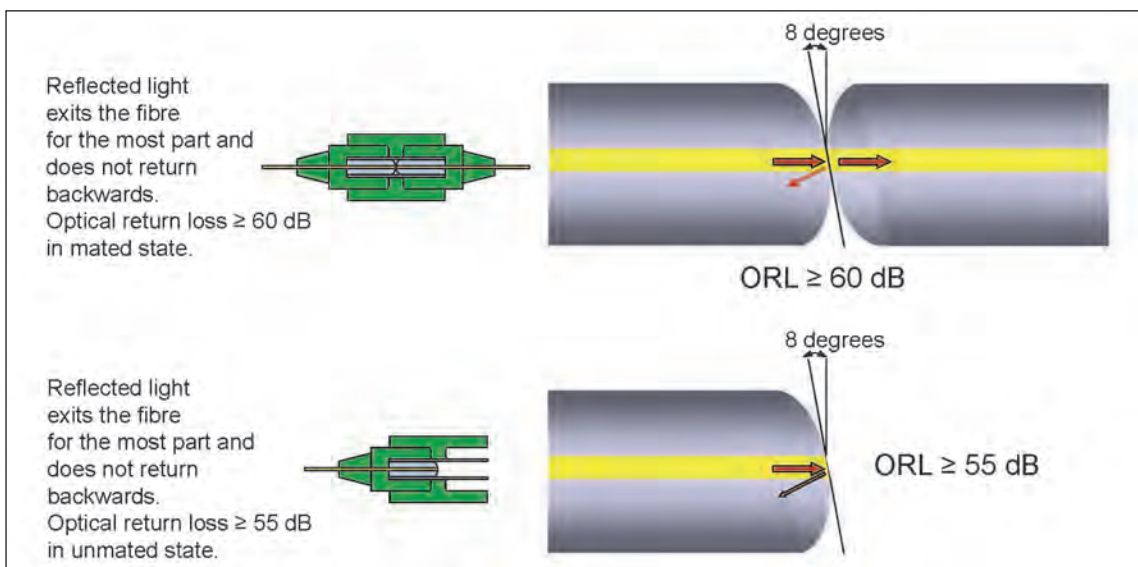

**b) APC connector**

Figure 4.3. Differences of UPC (figure a) and APC (figure b) polished connectors.

The grade and quality of polishing is an essential quality factor of an optical fibre connector. In order to achieve the required optical characteristics certain geometrical requirements shall also be met. The three most important geometrical parameters and recommended values for SC and LC connectors are:

- Radius of curvature. Recommendation are 10...25 mm for UPC and 5...12 mm for APC
- Apex offset. Recommendation is not more than 50  $\mu\text{m}$  for UPC and APC.
- Fibre undercut and fibre protrusion. Recommendation is not more than 0,05  $\mu\text{m}$  for UPC and APC.

These parameters are illustrated in figure 4.4.

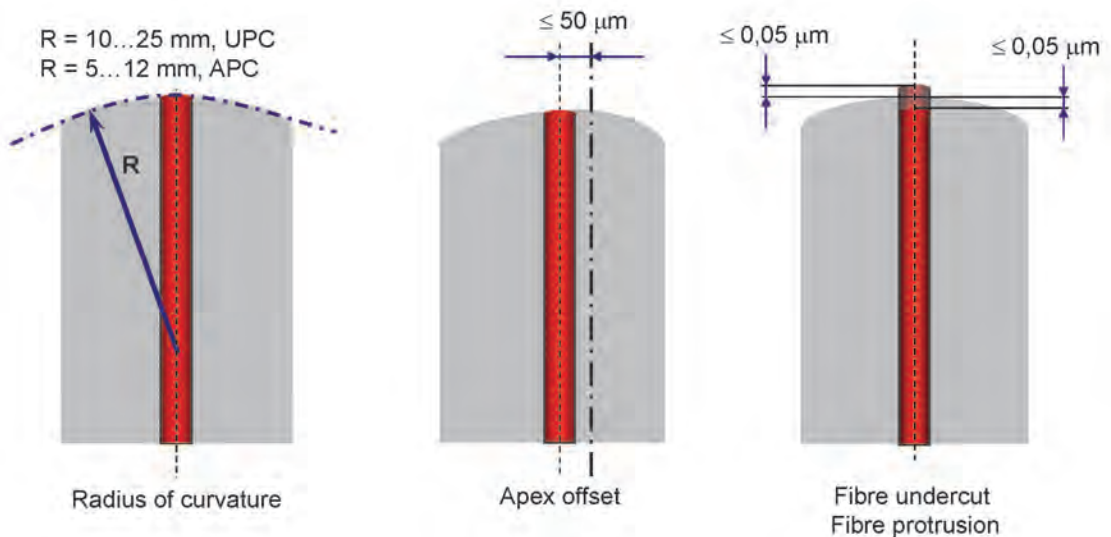

Figure 4.4. Polishing parameters for UPC polished ferrule.

In addition to compliance with the geometrical requirements described above the polished ferrule end shall have a clean and smooth surface. The ferrule end shall also be free from all kind of scratches or other defects. A good quality polishing requires using a special polisher. UPC and APC polishing are possible only in well controlled conditions and with special equipment, not in the field. The quality of polishing can be inspected with an interferometer. It is not possible to reliably evaluate the quality of polishing with a naked eye or even with a magnifying glass.

The ferrule of a connector has an essential role in the performance and reliability of a connection. The connector body and the adapter for their part are responsible for the alignment stability of a connection. The connector body shall have a sufficiently strong and durable construction and it shall enable an easy and a reliable attachment of an optical fibre or a single fibre cable to the connector. The connector shall also provide a strain relief and the insertion loss shall not be increased or the connection shall not be opened when the fibre or the cable is pulled with a specified force. The price of the connector depends very much on the ferrule. Therefore new and cheaper ferrule materials have been developed. An example of a new and promising ferrule type is the glass ceramic ferrule, which has the performance of full ceramic ferrule, but lower price.

The function of an adapter is to align two ferrule ends with fibres in such a way that there is no essential axial, lateral or angular displacement error in the connection. Ceramic alignment sleeves are more recommended than metallic (e.g. bronze).

#### 4.1.2 Common connector types

During the last 15...20 years the most common connector type both in singlemode and multimode technology has been the SC connector (see figure 4.5). The SC connector is a ferrule connector and it was originally developed in Japan (NTT). The connector has a plastic body and its cross section is rectangular. The connector is locked with clips when it is pushed into the adapter and it opens when it is pulled with moderate force. The ferrule of the SC connector and the alignment sleeve of the SC adapter are floating, which means that the connector body or adapter body do

not guide the alignment, but it is free. The ferrule is suspended with a spring in such a way that the ferrule ends are pressed towards each other with an appropriate force and a firm connection is born. The ferrule diameter is 2,5 mm.

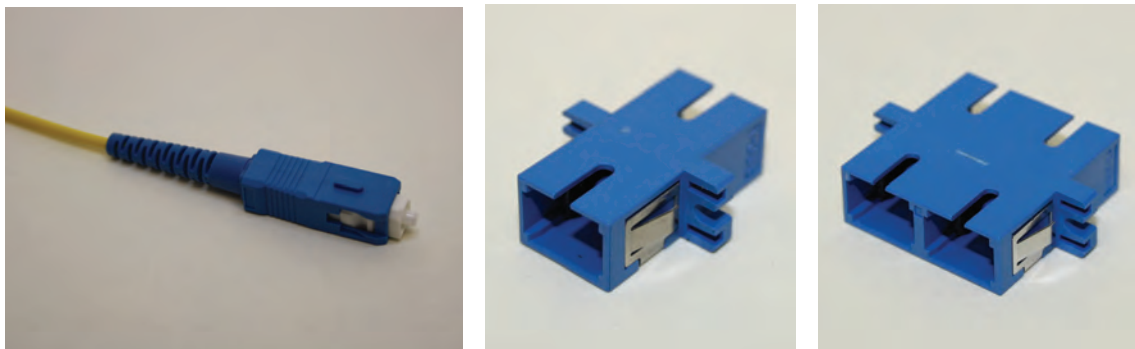

Figure 4.5. SC connector and simplex and duplex adapters.

SC connectors to be used with singlemode fibres are generally UPC or APC polished and SC connectors to be used with multimode fibres are generally SPC polished. A good quality connector has full ceramic (e.g. zirconium oxide) ferrule.

Typical characteristics of a good quality SC or LC connector are listed below:

- insertion loss:  $\leq 0,25$  dB
- return loss:  $\geq 50$  dB (UPC);  $\geq 60$  dB (APC)
- stability: change of insertion loss  $\leq 0,2$  dB
- repeatability:  $\geq 500$  connections
- ferrule polishing: radius of curvature 10...25 mm (UPC)/5...12 mm (APC); apex offset  $\leq 50$   $\mu$ m; fibre undercut/protrusion  $\leq 0,05$   $\mu$ m
- ferrule material: ceramic (zirconium oxide)
- alignment sleeve of adapter: ceramic (zirconium oxide)
- colour of connector body: SM – blue, SM/APC – green, MM – beige (OM1, OM2) or aqua (OM3, OM4).

The LC connector (figure 4.6) was originally developed in USA by Lucent. The performance is similar to the SC connector, but the size of the connector is half of the size of the SC connector. Also the locking system is different. The locking system of the LC connector is the same as in the RJ45 connector, which is commonly used in twisted pair cabling systems. The connector is coupled and locked by pushing and it is opened by pressing the locking latch towards the connector body and by pulling. The LC connector type has become very popular during recent years and it is going to override and replace the present main type SC.

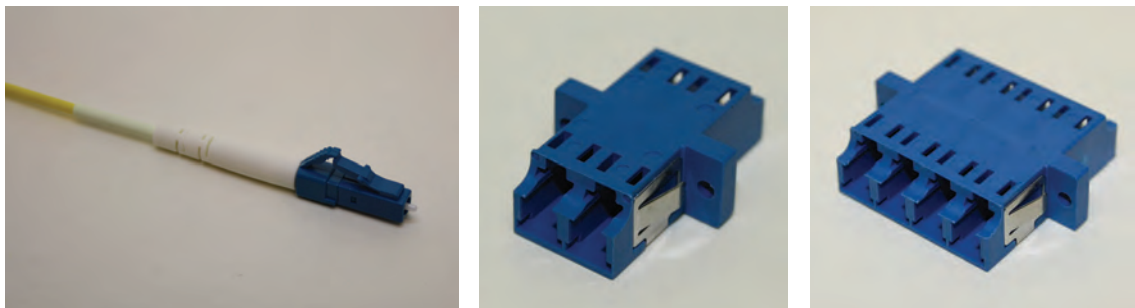

Figure 4.6. LC connector and duplex and quad adapters.



The mounting dimensions of the duplex-LC adaptor are equal to those of the SC adaptor and the mounting dimensions of the quad-LC adaptor are equal to those of the duplex SC adaptor.

The MU connector was also originally developed in Japan by NTT and its basic characteristics and performance are practically equal to those of the SC connector. The size of this connector type, however, is only half of the size of the SC type. Therefore the MU connector is also sometimes called mini SC. The ferrule diameter in the MU connector is 1,25 mm. The MU connector type has not become common in optical access network applications.

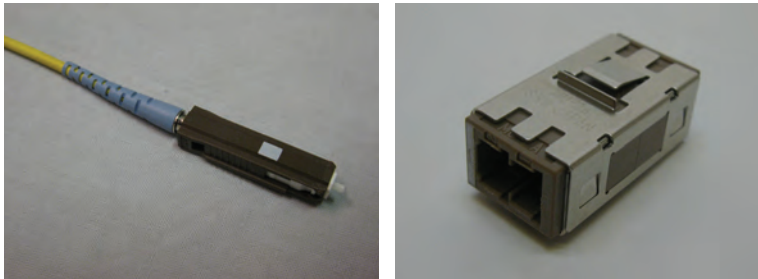

Figure 4.7. MU connector and adapter.

In cable plant installations the FC connector type was the main type before the SC connector. The FC connector type is not any more used in cable plant installations, but in test equipment the FC connector is still used. The FC connector has a metallic or plastic body and it is locked by screwing. FC connectors are PC polished in the same way as SC connectors and the ferrule type is the same as in the SC connector. Therefore the ferrules are compatible with each other and the SC connector can be connected with the FC connector by using SC-FC adapter.



Figure 4.8. FC connector and SC-FC adapter.

There are also connectors for fibre ribbons. These connectors can be used for connecting fibre ribbons with 2...24 fibres. Japanese have developed connectors for even 80 fibres. Such a connector consists of 5 connector modules each of which is capable to connect a ribbon with 16 fibres.

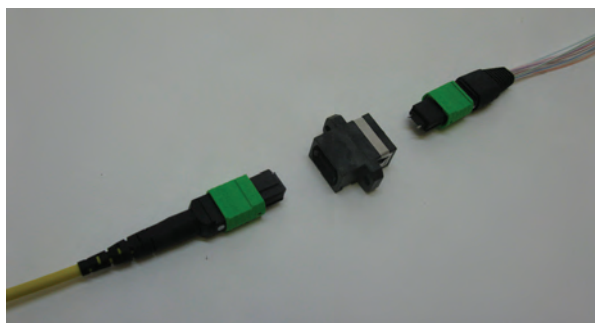

Figure 4.9. MPO connectors and adapter for 12 fibre ribbon.



### 4.1.3 Classification of connectors

Standard series IEC 61753 and IEC 61755 classify optical fibre connectors into four insertion grades and four return loss grades. The grades are shown in tables 4.1 and 4.2.

**Table 4.1.** Singlemode random mate insertion loss grades at 1310 nm (IEC 61753 and IEC 61755 series).

Insertion loss grade	Insertion loss (random/random), dB
A	Not yet specified
B	≤ 0,12 dB, mean; ≤ 0,25 dB, ≥ 97 %
C	≤ 0,25 dB, mean; ≤ 0,50 dB, ≥ 97 %
D	≤ 0,50 dB, mean; ≤ 1,0 dB, ≥ 97 %
Note: The insertion loss grades are specified for a mode field diameter (MFD) range of 9,2 +/- 0,4 μm of singlemode fibre (IEC 60793-2-50, B1.1, B1.3 and B6).	

**Table 4.2.** Singlemode return loss grades at 1 310 nm (IEC 61753 and IEC 61755 series).

Return loss grade	Return loss, dB
1	≥ 60 dB, mated* ≥ 55 dB, unmated*
2	≥ 45 dB, mated
3	≥ 35 dB, mated
4	≥ 26 dB, mated
* This requires APC type ferrule	

Standard series IEC 61753 also classifies optical fibre connectors and other passive components into four performance categories, which are based on operating service environments. The categories are shown in table 4.3.

**Table 4.3.** Performance categories and operating service environments for optical fibre connectors, passive components and fibre management systems. (IEC 61753-series).

Category	Description	Operating service environment
<b>C</b> (Controlled)	A controlled environment (typically within an office or building)	T: -10...+60 °C RH: 5...85 %
<b>U</b> (Uncontrolled)	An uncontrolled environment (typically outdoors but enclosed or covered)	T: -25...+70 °C RH: 10...100 %
<b>O</b> (Outdoor)	An uncontrolled environment (typically outdoors but enclosed or covered, sequential series of tests)	T: -40...+75 °C RH: 10...100 %
<b>E</b> (Extreme)	An extreme environment (typically outdoors but not enclosed)	T: -40...+85 °C RH: 0...100 %
T = temperature RH = relative humidity		

#### 4.1.4 Fibre pigtails, connectorized cables and patch cords

Fibre pigtails are used for fibre termination in patch panels, termination boxes and other termination points. Pigtails are typically tightly secondary coated (900 µm) fibres with an optical fibre connector only in one end. Typical lengths are 1,5 or 2 m. These lengths include sufficient working length for splicing the pigtails to the fibre of the cable. If a special protection is needed the pigtail fibre may be reinforced with aramid fibres and a plastic sheath (typ. 2 mm diameter). The fibres of the cable to be terminated are spliced to the pigtails. The connector ends of the pigtails are connected to the inside the patch panel to the adapters in the connector field. Splicing can be made either by fusion splicing or by mechanical splicing. Fusion splicing is recommended, because it results in better reliability and optical performance. The splice is mounted on the splice tray or on other fixture inside the patch panel or termination box. Figure 4.10 shows examples of fibre pigtails.



Figure 4.10. Examples of fibre pigtails.

The other way to terminate an (outdoor) cable is to use connectorized cables or cable assemblies. Connectorized cables are installation cables with a specified number of fibres (e.g. 6...48 fibres) and with pre-mounted connectors one end. The connectorized end of the cable is connected to the patch panel, termination box or connector field of distribution frame and the free end is spliced with the cable to be terminated.

Use of connectorized cable brings the following advantages, especially in termination of outdoor cables:

- Saving in work. No need to install rigid outdoor cables inside building where the spaces and pathways are narrow and tight. In indoor cabling between distributors one splice is saved.
- Easier termination work. Possibility to splice fibres and handle cables in more favourable conditions (e.g. more space).
- Fire safety. Outdoor cable is spliced to fire safe indoor cable at the entrance into the building.
- Minimizing the overvoltages in the case when the outdoor cable contains metallic elements.
- Cleanliness of distributors. No risk of contamination or dirt caused by handling the outdoor cables (e.g. jelly or gel).

A connectorized cable may have slotted core, stranded or central tube construction and the cable may be an indoor cable or an indoor/outdoor cable. The length of the cable can be specified as needed depending on the installation. The cable package type may be a coil or a drum. On market there are also cables with a pre-mounted patch panel in one end. Examples of connectorized cables are shown in figure 4.11.



Figure 4.11. Connectorized cables.

Patch cords are used to make cross-connections in optical distribution frames (ODF) and to connect active transmission equipment to the ODF or the patch panel. Patch cords are single or two fibre cables with connectors in both ends. A common cable construction in a patch cord is a tight secondary coated fibre surrounded with an aramid strength member and a sheath. The diameter of a single fibre cable is typically 2 mm.

The length and the connector type of a patch cord can be chosen as needed. Patch cords used for cross connections between patch panels or connector fields usually have the same connector type at both ends. Patch cords used for connections to equipment may have a different connector in the equipment end and in the panel end. Patch cords used in cross connections also often have a standard length. Typical lengths are 2 m, 3 m, 5 m and 10 m. Patch cords used in equipment connection may have a variety of lengths.

Figure 4.12 shows examples of patch cords.

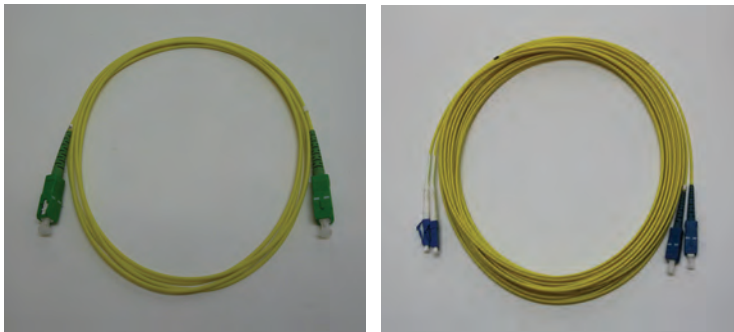

Figure 4.12. Examples of patch cords.

When choosing pigtails and patch cords the following aspects should be taken into account:

- connector type and performance
- fibre type and fibre specification
- number of fibres
- length
- materials and mechanical characteristics of patch cords
- required marking

#### 4.2 Other passive components

In addition to optical fibre connectors also some other passive components may be needed in the network. The following components can be mentioned:

- Splitters and tap couplers
- Attenuators
- Switches
- WDM components

Splitters are passive optical components, which are used to split the transmitted optical signal of one input fibre into two or more output fibres. The input signal is split equally into the output fibres. In the reverse direction the splitter combines two or more input signals into one output fibre. The number of splitter ports is expressed in the form of a ratio as 1:N, which is also called the splitting ratio. The principle of the splitter and a table with most common splitting ratios and the corresponding splitting losses are shown in figure 4.13.

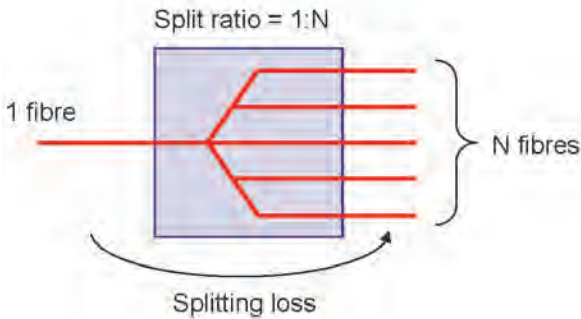

Split ratio	Splitting loss, dB
1:2	3,5
1:4	7,0
1:8	10,5
1:16	14,0
1:32	17,5
1:64	21,0
1:128	24,5

Figure 4.13. Common splitting ratios and splitting losses of splitters.

Splitters are available with pigtailed or with connectorized cords. Splitters with pigtailed may be mounted on the splice tray of a joint closure, patch panel or optical distribution frame. Splitters with connectorized cords are intended to be mounted in optical distribution frames or panel closures. See sub-clause 6.3.4 for recommendations of splitter implementations in PON-systems. Figure 4.14 shows examples of splitters.



Figure 4.14. Examples of splitters.

Tap couplers are passive optical components which are used to couple a certain (small) part of the transmitted optical signal of the input fibre into one tap fibre. While in the splitter the input signal is split equally into the output fibres, in the tap coupler the optical power in tap fibre is much smaller than in throughput fibre.

Optical attenuators are used to decrease the optical power level in the fibre. This may be necessary for example for the receiver. The attenuation of an optical attenuator may be fixed or variable with e.g. 5 dB steps. Optical attenuators are mainly male/female type connectors.



Figure 4.15. Fixed attenuator, male/female.

Optical switches are used to switch the fibre connection on and off or to switch the optical power of one input fibre to one of several output fibres. Typical switching times are about 10 ms. Optical switches may also be provided either with pigtailed or connectors.

With WDM technology the fibre capacity can be multiplied and very high capacities may be achieved. The most interesting and suitable WDM for access networks is the CWDM. The principles of CWDM and other WDM systems are discussed in clause 5.1.4. WDM components may be provided either with pigtailed or connectors. An example of CWDM component is shown in figure 4.16.



Figure 4.16. CWDM components with  $x$  channels.

### 4.3 Optical fibre termination boxes, patch panels and distributor mechanics

An optical fibre cables are typically terminated in the following situations:

- In distributors and equipment rooms of the optical access network (e.g. access node, outdoor distributor etc.)
- In building distributors, floor distributors and home distributors of residential premises
- In campus distributors, building distributors and floor distributors of office or industrial or other commercial premises

Closures and panels are needed for termination, interconnection and cross connection purposes. Building distributors in residential and commercial buildings and distributors (ODF) in teleoperator's buildings are typical places, where patch panels and termination boxes are used.

The most common components and mechanical structures for termination and jointing of optical fibre cables are described in the following clauses.

When choosing a termination box, patch panel or distribution rack at least the following aspects should be taken into account:

- structural clarity
- fixture and earthing (as required) of cables to be terminated
- ease of maintenance and changes
- expandability
- fibre and cable management when number of cables and fibres approaches the maximum capacity
- locking (as required)
- compatibility of specified connectors

### 4.3.1 Termination boxes

Termination boxes are closures or cases which are mounted directly on the wall without e.g. 19" installation rails. The fibres of the cable to be terminated are generally spliced to fibre pigtails within the box. Also connectorized cables can be used with termination boxes. In this case the fibre splices are located in a separate joint closure.

Termination boxes are mainly used when the number of fibres to be terminated is small (4...12... maybe 24) and when it is not possible to mount termination point in 19" rack. When planning the location of termination box the aspects related to protection and data security should be taken into account. Such aspects include locking of the box and protection of patch cords.

Termination boxes generally have capacity of 4...12 (24) connectors. Figure 4.17 shows examples of termination boxes.

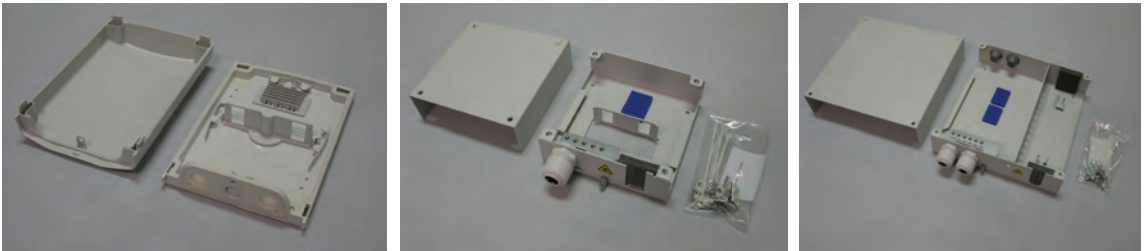

Figure 4.17. Examples of termination boxes.

In a single family house or in an apartment of a multi dwelling unit (MDU) the optical access fibres are typically terminated to a small termination box with a capacity of 2...4 fibres. This box may be installed in the home distributor cabinet of the single family house or the apartment of MDU. The home distributor is also the point where the cables of home cabling are terminated. Also all the active equipment required for the network services at home are installed in the home distributor cabinet. In a single family house the termination box may also be installed on the outer wall of the house. In this case an additional cabling through the wall from termination box into the interior of the house is needed.

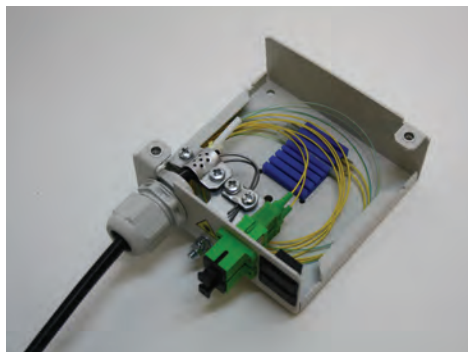

Figure 4.18. Termination box for a single family house and for an apartment of MDU.

### 4.3.2 Patch panels

Patch panels are constructional elements for termination and cross connection of optical fibre cables and they are commonly mounted in 19" rack. The patch panel construction consists of cable entries, splice trays or fixtures for fibre splices and connector field for equipment connections and cross connections. Protected fibre splices are mounted in the splice holders. The connector field consists of adapters, to which the connectors of fibre pigtails are connected inside the panel.



Patch panels are also very often provided with a protective storage space for excess lengths of patch cords.

A common capacity of one 19" patch panel is 24...48 SC connectors or 48...96 LC connectors. An example of a patch panel is shown in figure 4.19.



Figure 4.19. Examples of optical fibre patch panels.

### 4.3.3 Distributor mechanics

In distributors the optical fibre patch panels are mounted in racks or cabinets (later only term rack is used). The panel may be located in a separate cross connection rack or in the same rack or cabinet with the active transmission equipment. In big distributors, such as campus distributors of generic cabling or optical distribution frames (ODF) of public telecommunications network, patch panels and related connections should be allocated in their own racks. When choosing the rack construction fibre management and expandability should be taken into account. The rack construction may also be other than that of 19" mechanics. A rack construction designed especially for optical fibre termination and connections may be a good solution in many cases. In such racks the fibre management and expandability have been taken into account already in the basic design of the rack. This is not the situation with typical ordinary 19" racks. In these special racks instead of patch panels special connector blocks are used and adapters are mounted in these blocks. An example of optical fibre distribution racks is shown in figure 4.20.



Figure 4.20. Examples of optical fibre distribution racks used in an optical access network.

## 4.4 Joint closures and cabinets

Joint closures are needed for cable jointing and fibre splicing in the cable plant and at the cable entrance to the building. The most common components and mechanical structures for jointing of optical fibre cables are described in the following clauses. Jointing implementations are discussed in chapter 8.

When choosing the joint closure the following technical aspects should be taken into account where applicable:

- suitability for intended installation environment
- water tightness and possible hermeticity
- mechanical strength
- material compatibility with cable materials (e.g. electrochemical phenomena)
- applicability for various cable types
- number of cable entries and possibility for branching
- fibre splice capacity and space for other passive components (e.g. splitters)
- installation and maintenance characteristics, accessibility.

### 4.4.1 Joint closures and cabinets for outdoor installations

An outdoor cable is jointed by using an appropriate joint closure with required accessories. The size and construction of the closure shall be such which protects the fibres from environmental stresses and gives sufficient space for fibre splices and allowed fibre bending. The construction also should enable fastening of the strength members of the cables and earthing of the metallic elements of the cable as well as overvoltage protection when needed.

When choosing a joint closure for outdoor applications it is important to find out its applicability for different installation environments such as direct buried, manhole, cabinet, pole or underwater. Mechanical strength and water tightness are most important aspects. Both metallic and plastic closures are available. Examples of outdoor joint closures are shown in figure 4.21 and examples of closures in real installation environments are shown in figure 4.22.



Figure 4.21. Outdoor joint closures.



Figure 4.22. Installed outdoor joint closures.

In outdoor installations an alternative to a joint closure is a splice cabinet. Splice cabinets are located within another cabinet in order to get system with a good moisture protection. These kinds of cabinets have some certain advantages compared with closures. First they enable entries for several cables as well an easy maintenance, expandability and changeability. Secondly they can be provided with connector panels and used as distributors in areas where there is no possibility of an indoor distributor. Figure 4.23 shows examples of two installed splice cabinets.



Figure 4.23. Splice cabinets in their installation environment.

#### 4.4.2. Joint closures and cabinets for indoor installations

With indoor joint closures the environmental requirements are less critical than with outdoor joint closures. Indoor joint closures are used generally for jointing the outdoor cable to the indoor cable at the building entrance point. Another alternative is a wall mounted cabinet with sufficient space for connections and cable entries. There are also rack mounted solutions available. In indoor installations also a termination box may be used as a joint closure. This solution provides also possibility for connectors. Examples of an indoor joint closure and a splice cabinet shown in figure 4.24 and examples of the real installations are shown in figure 4.25.



Figure 4.24. Example of an indoor joint closure and splice cabinets.



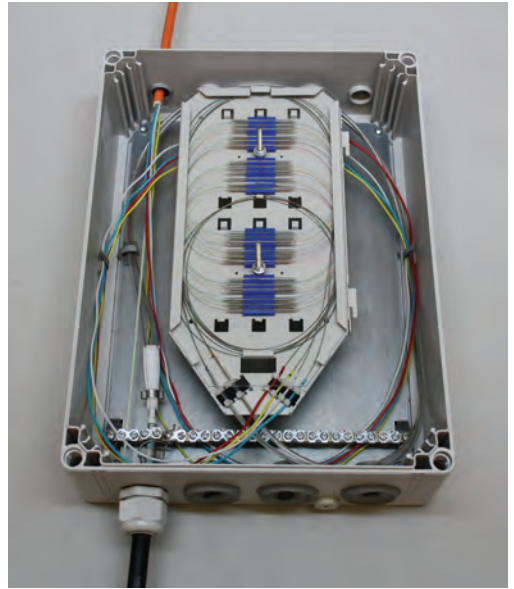

Figure 4.25. Installed indoor joint closure and splice cabinets.

## 5 Transmission technologies and network topologies

### 5.1 Overview of optical fibre transmission technologies

Transmission technologies used in optical fibre networks have undergone an enormous development during the last three decades, i.e. during the whole short era, when optical fibre cables and optical fibre transmission have existed. At first the development of optical fibre transmission technologies was driven by the traditional telecommunications, which were mainly telephone applications. Along with digitalization the significance of data transmission began to increase quickly and therefore also new transmission technologies had to be developed. Therefore in the 1990's also technologies based on packet switched technologies were brought widely into use in optical networks. At the same time the transmission rates of local area networks (LAN) were growing fast and it also became important to interconnect LANs in different geographic locations – even far from each other.

Ethernet has proved to be the superior LAN technology and the transmission rates of Ethernet-networks have grown in two decades from 10 Mbit/s to 100 Gbit/s, i.e. the transmission rates have been multiplied by 10000. This technology, which originally was intended for customer premises networks, has finally expanded into all levels of telecommunications networks: wide area, metropolitan area and access networks. The traditional concepts of telecommunications and data communications have become blurred and obscure. The modern and advanced telecommunications network has the nature of multiservice network, which can offer a great number of various services to all kinds of customers. Examples of such services are the Internet and other broadband data services, telephone (e.g. VoIP), television (IPTV) and video on demand (VoD).

#### 5.1.1 Ethernet

The use of Ethernet has expanded from local area networks (LAN) applications to core, regional and access networks. Today practically all connections of consumers and companies start and end with Ethernet (with IP protocol over Ethernet). In some network sections between the start and end point of the connection certain legacy technologies, such as ATM and SDH, are still used. Ethernet, however, is becoming the main technology in each network level.

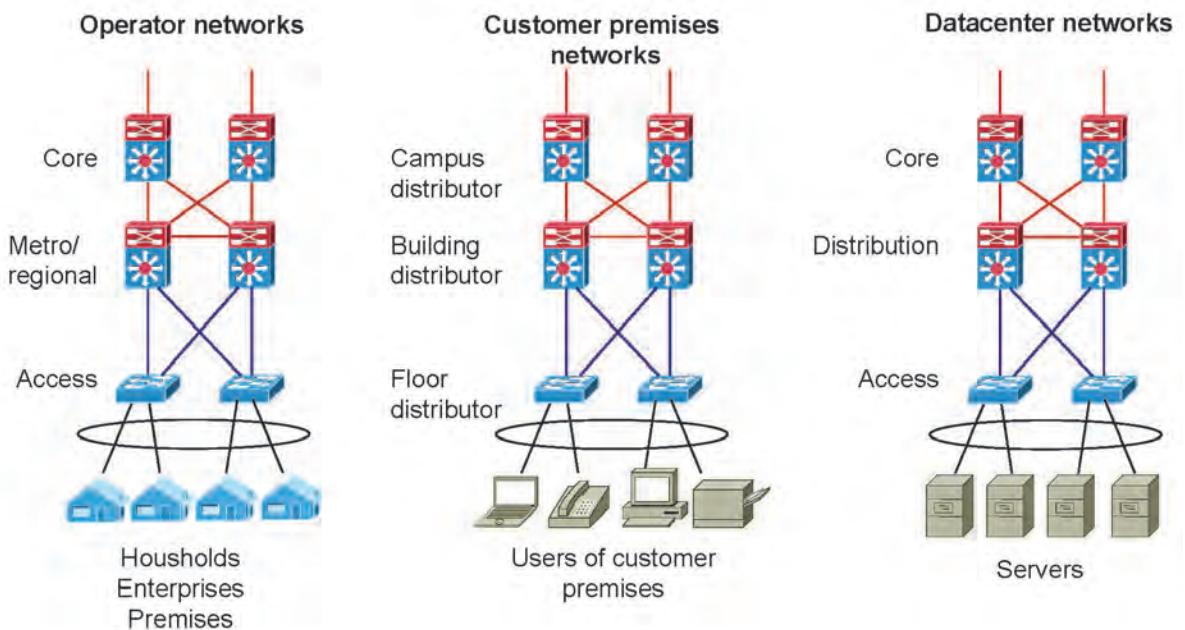

Figure 5.1. Same Ethernet technology in all kind of networks.

Ethernet as a technology is simple and well standardized. Products and systems are widely on the market and they are compatible with each other. Ethernet evolution has been continuous and forward looking since the beginning and new solutions for the future challenges have always been found. At the same time, however, the backward compatibility between different generations has never been a problem. The following advantages and benefits may be achieved with Ethernet:

- continuous "tube": LAN – MAN – WAN
- lower and less complicated protocol hierarchy in the access network
- less equipment, which also are less complicated
- less protocol conversions, shorter delays and more capacity
- lower costs

In the core network 10 Gbit/s Ethernet is common, but there is also more and more increasing need for 40 Gbit/s and 100 Gbit/s Ethernet. In regional or metro network 1 Gbit/s and 10 Gbit/s Ethernet are the most common.

Certain extensions to Ethernet are necessary to enable telecommunications network providers (carriers) to provide Ethernet services to customers and to utilize Ethernet technology in their networks. The result is called Carrier Ethernet. Metro Ethernet Forum (MEF) has prepared many specifications in order to promote adoption of Carrier Ethernet networks and services.

In the access network all Ethernet speeds from 10 Mbit/s to 10 Gbit/s or even more are available. IEEE has also published special technology standards for access network. This technology is called Ethernet in the First Mile (EFM) and the standards are IEEE 802.3ah and IEEE 802.3av. The standard IEEE 802.3ah specifies a number of Ethernet technologies for access network. These may be divided into three main groups:

- EFM copper (EFMC)
  - Ethernet over VDSL over telephone cable pair up to distance of 750 m.
  - Ethernet over SHDSL over voice grade telephone cable pair up to distance of 2700 m.
- EFM fibre (EFMF)
  - 100 and 1000 Mbit/s over singlemode fibre up to distance of 10 km.
- EFM PON (EFMP)
  - 1000 Mbit/s over passive optical network (singlemode fibre) up to distance of 20 km.

The latest achievement in IEEE access network standardization is 10 Gbit/s EPON standard IEEE 802.3av, which specifies Ethernet passive optical network with 10 Gbit/s transmission rate.

All the above mentioned Ethernet access network technologies are discussed more in clauses 5.3 and 5.4 of this book.

Some important milestones of Ethernet standardization are shown in table 5.1.



**Table 5.1.** Milestones of Ethernet standardization (IEEE).

Standard	Name	Transmission rate	Cable type	Year of publication
IEEE 802.3	10Base5	10 Mbit/s	Coaxial cable (thick)	1983
IEEE 802.3a	10Base2	10 Mbit/s	Coaxial cable (thin)	1985
IEEE 802.3d	FOIRL	10 Mbit/s	Multimode fibre	1987
IEEE 802.3i	10Base-T	10 Mbit/s	Twisted pair cable (cat 3)	1990
IEEE 802.3j	10Base-F	10 Mbit/s	Multimode fibre	1993
IEEE 802.3u	100Base-T 100Base-FX	100 Mbit/s 100 Mbit/s	Twisted pair cable (cat 5) Multimode fibre	1995
IEEE 802.3z	1000Base-SX 1000Base-LX	1000 Mbit/s 1000 Mbit/s	Multimode fibre Multimode or singlemode fibre	1998
IEEE 802.3ab	1000Base-T	1000 Mbit/s	Twisted pair cable (cat 5e)	1999
IEEE 802.3ae	10GBase-SR/SW 10GBase-LR/LW 10GBase-ER/EW 10GBase-LX4	10 Gbit/s 10 Gbit/s 10 Gbit/s 10 Gbit/s	Multimode fibre (cat OM3) Singlemode fibre Singlemode fibre Multimode fibre (WDM)	2002
IEEE 802.3af	PoE: Power over Ethernet, twisted pair cable			2003
IEEE 802.3ah	10PASS-TS 2BASE-TL 100BASE-LX10 100BASE-BX10 1000BASE-LX10 1000BASE-BX10 1000BASE-PX10 1000BASE-PX20	10 Mbit/s 2 Mbit/s 100 Mbit/s 100 Mbit/s 1000 Mbit/s 1000 Mbit/s	Telephone cable Telephone cable Singlemode fibre Singlemode fibre Singlemode fibre Singlemode fibre	2004
IEEE 802.3an	10GBase-T	10 Gbit/s	Twisted pair cable (cat 6A)	2006
IEEE 802.3aq	10GBase-LRM	10 Gbit/s	FDDI grade multimode fibres	2006
IEEE 802.3at	PoE Plus: Power over Ethernet , twisted pair cable, 24 W/eqp.			2009
IEEE 802.3av	10G EPON	10/10 Gbit/s 10/1 Gbit/s	Singlemode fibre	2009
IEEE 802.3ba	40GBASE-CR4 40GBASE-SR4 40GBASE-LR4 100GBASE-CR10 100GBASE-SR10 100GBASE-LR4 100GBASE-ER4	40 Gbit/s 40 Gbit/s 40 Gbit/s 100 Gbit/s 100 Gbit/s 100 Gbit/s 100 Gbit/s	Twisted pair cable 4 x OM3/4 fibres/direction Singlemode fibre + WDM Twisted pair cable 10 x OM3/4 fibres/direction Singlemode fibre + WDM Singlemode fibre + WDM	2010

### 5.1.2 Internet Protocol (IP)

The core of IP networks is the Internet Protocol (IP). IP is not actually a transmission system, but it is a telecommunications protocol of network layer (layer 3 in the OSI model) and it executes telecommunications services between any two terminal equipment in the network. Physical networks are interconnected with routers. A router is an equipment, which has an interconnection

with at least two networks and which routes IP datagrams between these networks. Each terminal equipment in the Internet has its own IP address, to which the other terminal equipment may send IP datagrams and according to which the IP datagrams are routed. The worldwide Internet consists of a huge number of routers and this network of routers enables any two terminal equipment to communicate with other, if they know each other's IP addresses.

IP is a connectionless protocol. This means that no connection is established when datagrams are sent. The datagrams are just sent to the network and the best is hoped. The network delivers each datagram to the destination independently and without any dependence on the other datagrams. The route of successive datagrams from sender to receiver may vary and the order of received datagrams may be different from that of sent datagrams. IP does not guarantee the successful receiving of the datagrams – this is the task of the higher level protocols. The higher level protocols are also responsible for error detection and correction.

The capacity in the IP network is shared efficiently, because the available capacity is IP always shared among those users who need it. The IP protocol always makes the best effort to transmit the datagrams to their destination as perfectly and fast as possible, but it does not guarantee a certain capacity to any datagram. If the network becomes congested, a part of the datagrams is rejected. In this the higher level protocols take care of resending the datagrams, as needed.

An IP datagram may contain data from any application. In other words: any data over IP is possible. E-mail, www and file transfer were the first and most important applications in the 1980's. Today voice over IP (VoIP) is becoming widely general and the next popular and fast growing IP applications will be IP television (IPTV) and Video on Demand (VoD). The applications generally work over a protocol of transport layer, not directly over IP. Transport layer is the layer 4 of the OSI model and the main protocols of this layer are the Transmission Control Protocol (TCP) and the User Datagram Protocol (UDP). Both TCP and UDP are point-to-point protocols, which are executed in terminal equipment and which do not affect the network. TCP includes an advanced error correction, flow control etc. and provides reliable bidirectional connection-based transmission services to applications. E-mail and www are typical applications using TCP. UDP is a connectionless protocol, which only includes sub addressing and simple error detection. Real time applications, such as VoIP and IPTV are typical applications using UDP.

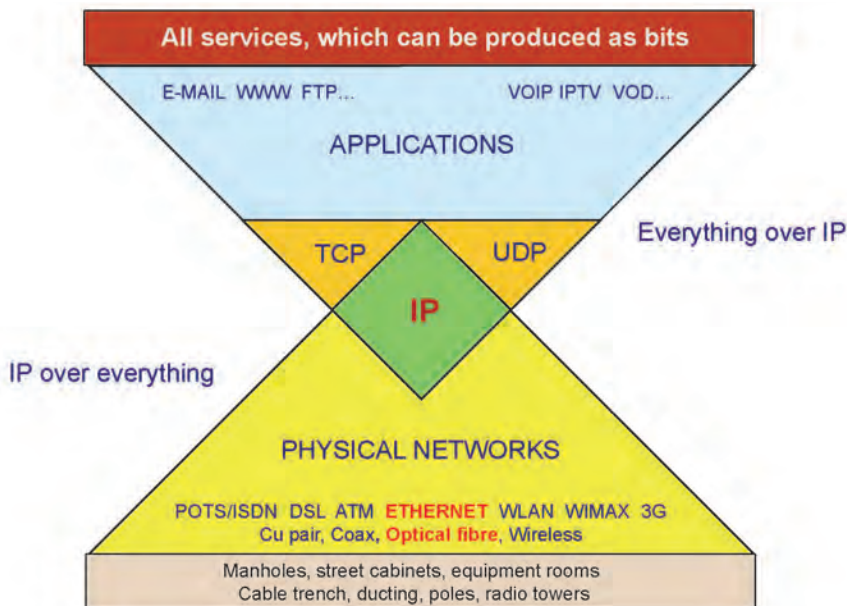

Figure. 5.2. IP works in all kind of physical networks and all kind of applications work over IP.

Almost whatever transmission/telecommunications network may be used to connect to the Internet or some other IP network. A few examples may be mentioned: traditional analogue telephone network (POTS), ISDN, ATM, xDSL, Ethernet, mobile networks (GSM; GPRS; EDGE, UMTS, LTE) and wireless local area (WLAN) or wide area networks (WMAN, Wimax).

One of the main strengths of IP is the fact that IP works in all kinds of physical networks and all kinds of application work over IP. The famous phrase is: "IP over everything – everything over IP". Applications do not depend on physical networks and they work over the generic IP. New applications may be developed for the existing networks and no new application specific network infrastructure is needed. New and more cost efficient network technologies may also be taken into use without needs to change the applications. The Ethernet evolution is a good example of this: 10 Mbit/s → 100 Mbit/s → 1 Gbit/s → 10 Gbit/s → 40 Gbit/s → 100 Gbit/s ...

### 5.1.3 Transmission of TV programs and other video signals

In cable television system optical fibre cables are used in trunk networks and also more and more in branch networks. Migrating to the optical fibre cable has been driven by the advantages of optical fibre cables (small size, low attenuation, etc.) and also the price development of the terminal equipment.

The optical fibre systems used in cable television systems are AM systems or FM systems. Fibre type in both systems is the singlemode fibre. Am system is more common system than FM system.

In the AM system the broadband signal (e.g. 85...862 MHz) to be transmitted modulates the laser transmitter and the intensity of the light propagating in the fibre follows this modulation. The optical signal is just the optical equivalent for the electrical signal. The receiver detects the received optical power and converts it to an electrical form, i.e. to high frequency broadband signal (85-863 MHz). After detection the signal is amplified.

The AM system may be used for transmission of traditional AM-VSB-modulated analogue TV-signals or QAM-modulated digital TV-signals. From the transmission point of view also the transmission of digital DVB-C-signals are analogue, although the information carried by the QAM-signal is digital. This digital information is, however, carried by the amplitude and phase of RF-frequencies. Figure 5.3 shows the simplified principles of AM-VSB and DVB-C. It should also be noticed that the QAM -modulated DVB-C-signal generally contains a multiplex of 3...5 program channels and not only one program channel as is shown in figure 5.3. The multiplex is formed by multiplexing the digital signals of 3...5 program channels into one bit stream. The newer DVB-C2-technology further increases the capacity of one RF-channel (8 MHz) and enables efficiently also HDTV distribution in cable television network.

Both 1310 nm and 1550 nm wavelengths may be used in AM systems. In shorter distances (below 40 km) it is more cost efficient to use 1310 nm system. In longer distance 1550 nm wavelength is used. 1550 nm wavelength is used also in WDM systems, when one fibre is used for data and TV transmission.

In the FM system the signals to be transmitted are frequency modulated in an electrical form and this RF-signal is used to modulate the laser transmitter. In the receiver the optical signal is first converted into electrical form and then the RF signal is demodulated to audio and video signals. The minimum input level in a FM receiver is very small. This is the most important advantage of FM systems, because longer transmission distances can be achieved. FM systems, however, are more expensive than AM systems.

Internet Protocol Television (IPTV) represents a totally new and fully digital technology in broadcast TV and other video transmission. In IPTV the analogue video signal is digitalized and encoded into MPEG-2 or MPEG-4-format. The same operations and conversions are made also to the voice. The digital and encoded video and audio signals are packed in IP datagrams, which are transmitted (routed) in an IP network. In IPTV also a protocol of the transport layer (layer 4 of

the OSI model) is needed and it is UDP. An additional protocol in IPTV is also RTP (Real Time Protocol), which has been developed especially for real time applications. The IP datagrams are transmitted over the data link layer (layer 2 of the OSI model), which typically is implemented with Ethernet. The protocol hierarchy of the digital video signal is MPEG/RTP/UDP/IP/Ethernet as shown in figure 5.2.

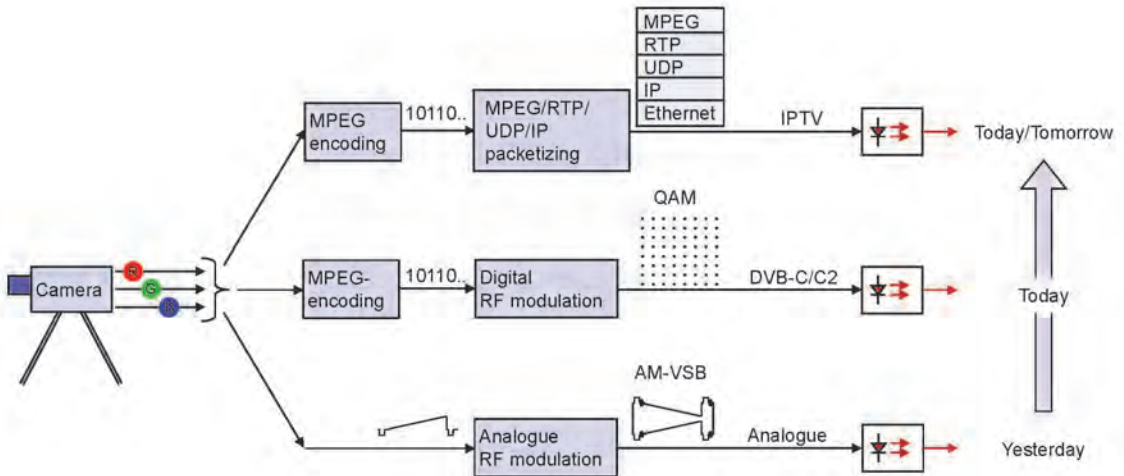

Figure 5.3. Simplified principles of AM-VSB, DVB-C/C2 and IPTV.

#### 5.1.4 WDM technology

Wavelength Division Multiplexing (WDM) is a technology which is used to increase the capacity of one fibre by utilizing more than one wavelength. This means that several optical signals can be transmitted at different wavelengths and the signals do not disturb each other during the transmission. The three main types of WDM technologies and their characteristics are the following:

- WWDM (Wide Wavelength Division Multiplexing)
  - Simplest WDM technology
  - Channel spacing at least 50 nm
  - Two or three wavelength ranges: 1310 nm, 1490 nm and 1550 nm
  - This technology is used to provide bidirectional traffic in one optical fibre
  - Downstream: 1550 nm and/or 1490 nm, upstream: 1310 nm
- CWDM (Coarse Wavelength Division Multiplexing)
  - Wavelengths are specified in the Recommendation ITU-T G.694.2
  - Maximum 18 wavelengths with 20 nm intervals in the wavelength range 1270...1610 nm
  - Suitable for regional and access networks
  - More cost effective than DWDM
  - Fibre type ITU-T G.652.D
- DWDM (Dense Wavelength Division Multiplexing), ITU-T G.694.1
  - Wavelengths are specified in the Recommendation ITU-T G.694.1
  - Channel spacing: 200 GHz, 100 GHz, 50 GHz, 25 GHz or 12,5 GHz (corresponding wavelength intervals are app: 1,6 nm, 0,8 nm, 0,4 nm, 0,2 nm or 0,1 nm)
  - Frequencies/wavelength in C and L bands.

- High laser stability required.
- Suitable for core and long distance networks with very high capacity
- Technology used in WDM PON
- Fibre types ITU-T G.652.D or special DWDM fibres ITU-T G.655 and ITU-T G.656

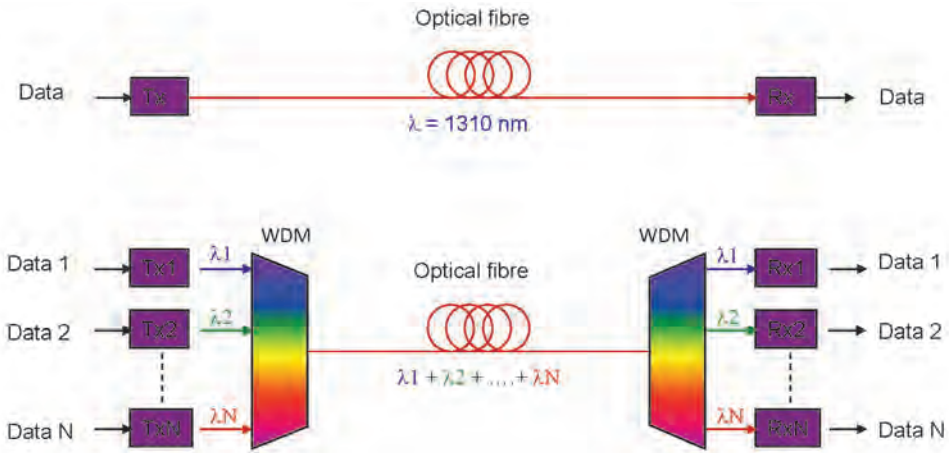

CWDM: Coarse wavelength division multiplexing. Wavelengths with 20 nm spacing in the range 1270... 1610 nm.  
 DWDM: Dense wavelength division multiplexing. Wavelengths with 1,6 nm, 0,8 nm, 0,4 nm, 0,2 nm or 0,1 nm spacing in the range 1530... 1565 nm.

Figure 5.4. Increasing of capacity by using WDM.

With WDM technology the fibre capacity can be multiplied and very high capacities may be achieved. The most interesting and suitable WDM for access networks is the CWDM.

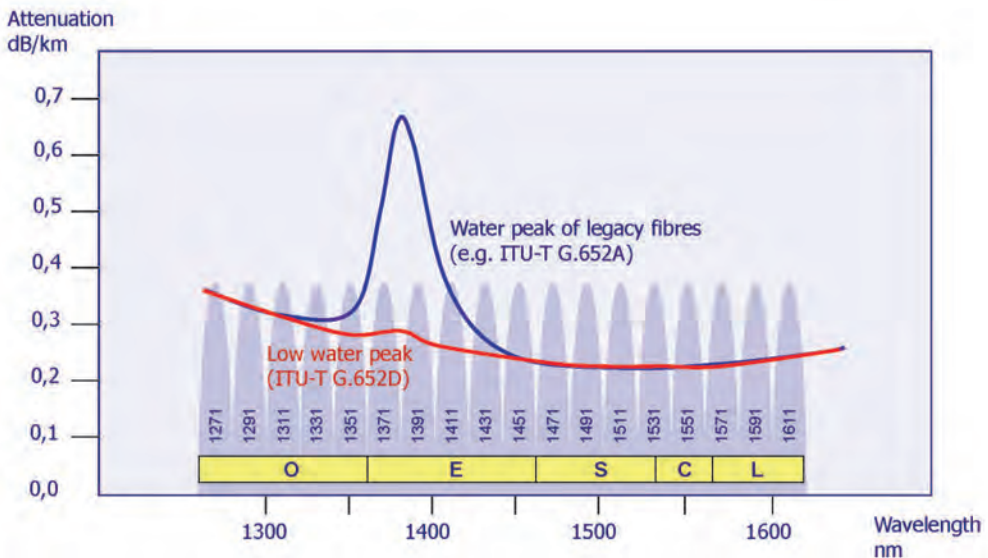

Figure 5.5. CWDM channels according to ITU-T G.694.2.



## 5.2 Basic network topologies

The structure of the network is commonly described by using the term topology. Topology means the geometrical and logical form of the network and it can be defined in different levels of the network. In this chapter we discuss the logical topologies, which describe the logical connections of the data traffic. In chapter 6 of this book also fibre and cable topologies are discussed. In this stage it is sufficient to be mentioned that the logical topology, the fibre topology and the cable topology of the same network do not necessary look the same.

Commonly three different logical topologies are defined for the access network. These are the following:

- a) Full star topology with point-to-point (P2P) links. Each customer interface is connected with an own fibre to the access node.
- b) Active star topology with point-to-point (P2P) links. Each customer interface is connected with an own fibre to the local switch (curb switch, village switch, etc.). This switch is connected with a trunk fibre to the access node. The trunk fibre is thus shared by several customers.
- c) Passive optical network (PON). Point-to-multipoint-topology (P2MP), where the trunk fibre is shared by several customers by using a passive splitter. Each customer interface is connected with own fibre to the splitter.

These three topologies are illustrated in figure 5.6.

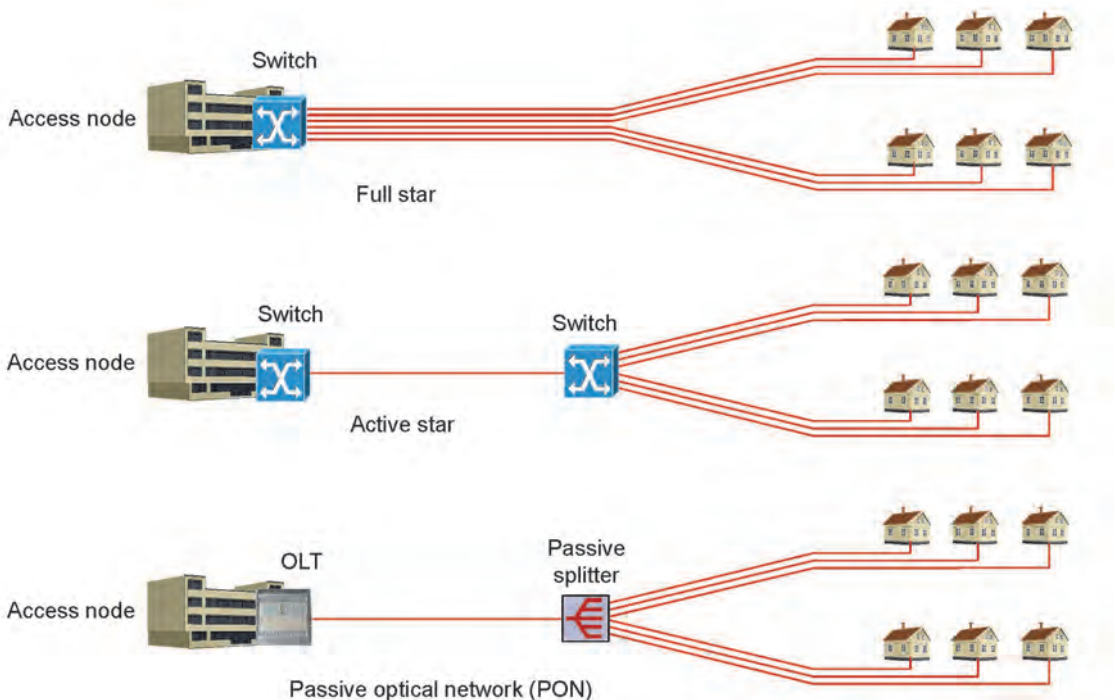

Figure 5.6. Three different topologies of the access network.

It should be noticed that the three examples of the figure 5.6 are simplified and are based on one fibre system. The same principle can, however, be applied to two fibre systems. The numbers of fibres shown in the figure should just be doubled in this case. It should be noticed that both the number of fibres and the number of transmitters/receivers depend on the chosen topology. The examples in figure 5.6 are intended to illustrate the factors which are important when choosing the topology. The number of fibres in the optical access network should in all cases be greater than the minimum number required by the system. The recommended numbers of fibres for different sections of the network are discussed in clause 6.3.



### 5.3 Point-to-point Ethernet topologies

Figure 5.7 shows an example of an optical access network with P2P topology and using transmission rates 100 Mbit/s and 1000 Mbit/s. The point-to-point topology (P2P) technologies are actually just access network applications of standardized 100 Mbit/s and 1 Gbit/s Ethernet technologies. Use of two wavelengths in one fibre versions, however, is an additional feature. The basic nature of these networks is a switched local area network with a large geographical coverage and with the specified transmission rates 100 Mbit/s and 1 Gbit/s. The protocol of the data link layer (layer 2 of the OSI model) is CSMA/CD, as in general with Ethernet networks. The structure of the Ethernet frames transmitted in the network is in accordance with the standard IEEE 802.3 and is shown in figure 5.8.

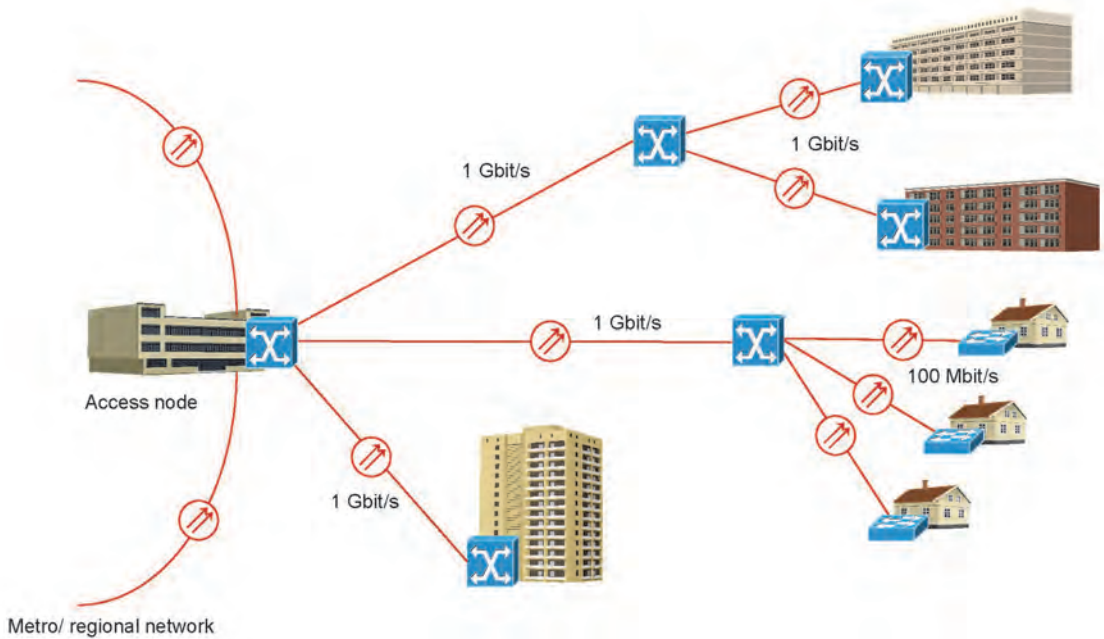

Figure 5.7. Optical access network with P2P topology.

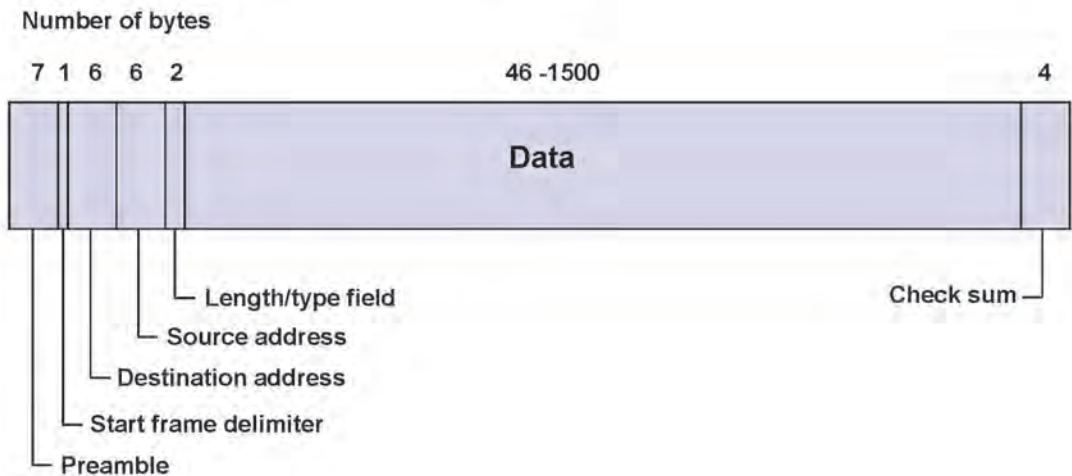

Figure 5.8. Ethernet frame according to the standard IEEE 802.3.

Both ITU-T and IEEE have published standards, which specify P2P Ethernet access network technologies. The most important standards are:

- ITU-T G.985: 100 Mbit/s point-to-point Ethernet based optical access system:
  - One fibre system, distances 10 km, 20 km tai 30 km
- ITU-T G.986: 1 Gbit/s point-to-point Ethernet-based optical access system:
  - One fibre system, distances 10 km, 20 km tai 30 km
- IEEE 802.3ah: Ethernet in the First Mile (EFM):
  - 100BASE-LX10: 100 Mbit/s Ethernet, one fibre system, distance 10 km
  - 100BASE-BX10: 100 Mbit/s Ethernet, two fibre system, distance 10 km
  - 1000BASE-LX10: 1000 Mbit/s Ethernet, one fibre system, distance 10 km
  - 1000BASE-BX10: 1000 Mbit/s Ethernet, two fibre system, distance 10 km
- Wavelengths in one fibre systems:
  - Downstream: 1490 nm (1550 nm in 100BASE-BX10)
  - Upstream:1310 nm
- In two fibre systems wavelength 1310 nm is used in both directions.

Tables 5.2 and 5.5 summarize the main characteristics of the physical layer of P2P Ethernet technologies. As can be seen from tables the technologies specified by ITU-T and IEEE are very much similar. ITU-T, however, specifies longer distances than IEEE. The reason for this that the objective of IEEE has been a most cost effective technology with sufficient performance. Therefore the specifications of IEEE are based on smaller distances, which means smaller attenuation budgets. The second difference is the additional two fibre option in IEEE standards.

**Table 5.2.** Characteristics of 100 Mbit/s point-to-point-Ethernet access technology according to ITU-T G.985.

Characteristics	Class S	Class A	Class B
Fibre type	Singlemode fibre ITU-T G.652.D		
Number of fibres	1		
Transmission direction	Downstream / upstream		
Wavelength	1480...1580 nm / 1260...1360 nm		
Maximum distance	10 km	20 km	30 km
Maximum attenuation	15 dB	Under consideration	Under consideration

**Table 5.3.** Characteristics of 1000 Mbit/s point-to-point-Ethernet access technology according to ITU-T G.986.

Characteristics	Class S	Class A	Class B
Fibre type	Singlemode fibre ITU-T G.652.D		
Number of fibres	1		
Transmission direction	Downstream / upstream		
Wavelength	1480...1500 nm / 1260...1360 nm		
Maximum distance	10 km	20 km	30 km
Maximum attenuation	15 dB	20 dB	25 dB

**Table 5.4.** Characteristics of 100 Mbit/s point-to-point-Ethernet access technology according to IEEE 802.3ah.

Characteristics	100BASE-LX10	100BASE-BX10-D	100BASE-BX10-U
Fibre type	Singlemode fibre IEC 60793-2-50 B1.1 or B1.3 (ITU-T G.652.D)		
Number of fibres	2	1	
Transmission direction	Downstream / upstream	Downstream	Upstream
Wavelength	1310 nm	1550 nm	1310 nm
Maximum distance	10 km		
Maximum attenuation	6,0 dB	5,5 dB	6,0 dB

**Table 5.5.** Characteristics of 1000 Mbit/s point-to-point-Ethernet access technology according to IEEE 802.3ah.

Characteristics	1000BASE-LX10	1000BASE-BX10-D	1000BASE-BX10-U
Fibre type	Singlemode fibre IEC 60793-2-50 B1.1 or B1.3 (ITU-T G.652.D)		
Number of fibres	2	1	
Transmission direction	Downstream / upstream	Downstream	Upstream
Wavelength	1310 nm	1490 nm	1310 nm
Maximum distance	10 km		
Maximum attenuation	6,0 dB	5,5 dB	6,0 dB

The standard IEEE 802.3ah also specifies two EFM technologies for copper telephone cables.

These technologies enables to use DSL connections for Ethernet transmission. The achievable transmission rates depend on the DSL technology used and the characteristics of the copper network (length, performance and quality of the subscriber loop). Typical transmission rates are 2...100 Mbit/s. Figure 5.9 shows an example of a network utilizing both optical fibre and copper cable EFM technology.

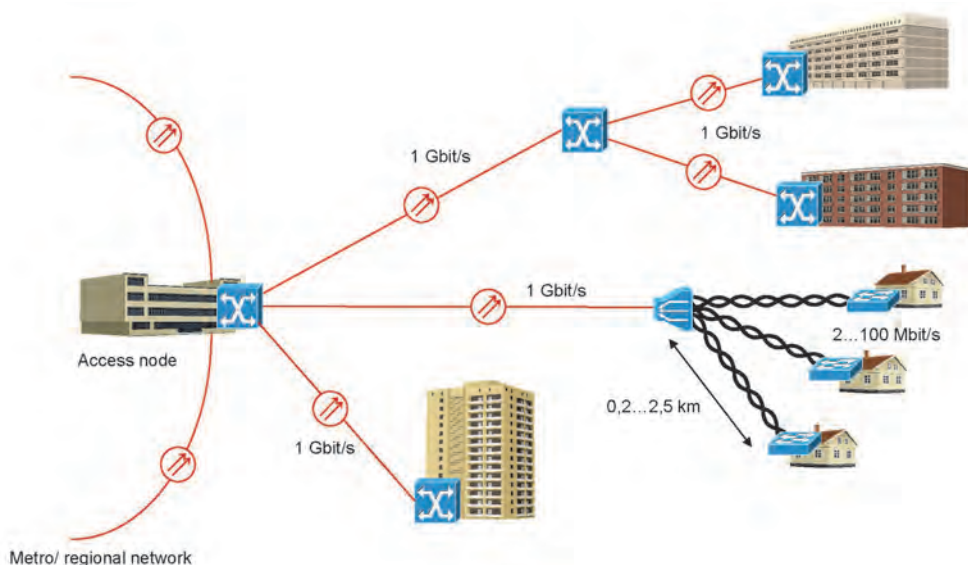

*Figure 5.9 An access network utilizing both optical fibre and copper cable EFM technology.*

IEEE has also published standards for 10 Gbit/s, 40 Gbit/s and 100 Gbit/s Ethernet (see table 5.1). These technologies are mainly used in core and metro/regional networks.

## 5.4 Point-to-multipoint topologies or passive network topologies

### 5.4.1 Principles of PON

Optical networks may be divided into two main groups: active and passive networks. In an active network there is one or more active equipment (e.g. repeater or switch) between the access node and the customer terminal equipment. In a passive network no such equipment exists and the network consists of only passive components. Typical such passive components are – in addition to the optical fibre – optical fibre connectors, splitters and WDM components.

The abbreviation PON is commonly used instead of the complete name Passive Optical Network. The principal structure of PON is shown in figure 5.10. The topology of a PON network is point-to-multipoint. Point-to-multipoint is also commonly abbreviated as P2MP.

The active equipment in the central office or access node is called Optical Line Terminal (OLT) and the customer terminal equipment is called Optical Network Unit (ONU). Some typical telecommunications services of PON are also shown in the figure.

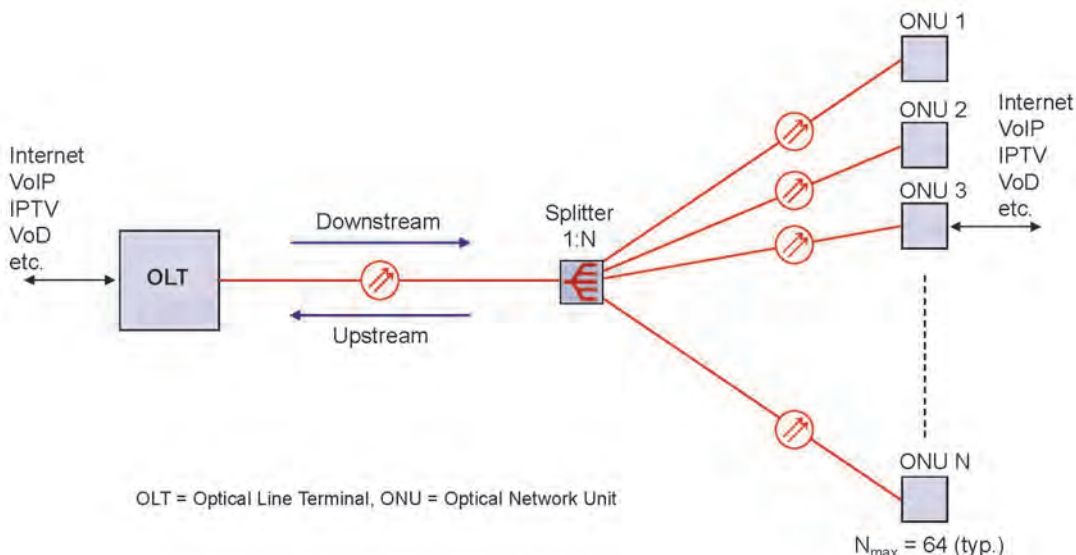

Figure 5.10. The principal structure of PON network.

Most PON networks are designed to work with one optical fibre per connection. The OLT in the access node feeds the access network with one trunk fibre which is shared by several customers by using an optical fibre splitter. The splitting ratio may be as high as 64, which means that one OLT serves 64 ONUs. One ONU may also serve one or more individual customers. The bidirectional data traffic in one fibre is possible, because different wavelengths are used in the two directions. The direction from OLT to ONU is called downstream direction and the opposite direction is called upstream direction.

The type of PON is indicated by a letter in front of the abbreviation PON. The most common PON networks are the following:

- GPON (Gigabit-capable PON): 2,5 Gbit/s / 1,2 Gbit/s
  - ITU-T G.984-series
- XG-PON (10 Gigabit-capable PON): 10 Gbit/s / 2,5 Gbit/s
  - ITU-T G.987-series

- EPON (Ethernet PON): 1 Gbit/s / 1 Gbit/s
  - IEEE 802.3ah
- 10G-EPON: 10 Gbit/s / 1 Gbit/s and 10 Gbit/s / 10 Gbit/s
  - IEEE 802.3av
- RFoG (RF over Glass)
  - SCTE 174 2010
  - Fully fibre optical cable television system
- WDM-PON
  - Under development
  - No standard published yet
  - Several technological alternatives
- Older PON-standards that have practically lost their significance:
  - APON (ATM PON)
  - BPON (Broadband PON), ITU-T G.983-series

GPON, XG-PON, EPON 10G-EPON and WDM-PON are described briefly in clauses 5.4.2...5.4.4 of this book.

GPON, XG-PON, EPON 10G-EPON are so called TDM-PON networks. This means that the upstream capacity is managed by using time division multiplexing (TDM). Each ONU is allowed to transmit information only during the time slot granted to it. It is very important to understand the following feature of TDM-PON networks: in the downstream direction TDM-PON represents point-to-multipoint topology (P2MP), but in the upstream direction it consists of several point-to-point (P2P) topology connections. And the traffic of these point-to-point connections requires a strict control. In WDM-PON each ONU receives and transmits at its own dedicated wavelength. This means in the same physical network topology several logical P2P-topologies can be implemented.

## 5.4.2 PON technologies specified by ITU-T

The most important PON technologies specified by ITU-T are GPON and XG-PON.

### 5.4.2.1 GPON

GPON is a universal PON technology which supports a great amount of digital telecommunications applications. GPON was developed to overcome the restrictions of BPON and it is specified in the recommendations ITU-T G.984.1...G.984.6.

The most important characteristics of GPON in the physical layer (layer 1 of the OSI model) are the following:

- Transmission rates: 1,24416 or 2,48832 Gbit/s in downstream direction and 0,15552, 0,62208, 1,24416 or 2,48832 Gbit/s in upstream direction.
- Wavelengths: 1260...1360 nm in upstream direction and 1480...1500 nm in downstream direction.
- Traffic types: Bidirectional digital
- Fibre count: 1 or 2 fibres
- Splitting ratio: max 64 , limited by the passive network attenuation
- Attenuation of the passive network between OLT and ONU, including all attenuation factors (fibre, connectors, splitters, etc.):
  - Class A: 5...20 dB
  - Class B: 10...25 dB



- Class B+: 13...28 dB
- Class C: 15...30 dB
- Class C+: 17...32 dB
- Maximum distance: 20 km with DFB laser, 10 km with Fabry-Perot laser
- Recommendation ITU-T G.984.6 specifies GPON systems with extended reach using a regenerator or optical amplifier in the fibre link between OLT and ONU. The maximum reach is up to 60 km with loss budgets of in excess of 27,5 dB being achievable in both spans.

Only digital telecommunications services have been specified for GPON. Cable television transmission (RF overlay) , however, is possible in the wavelength range 1550...1560 nm in downstream direction. ITU-T G.984.5 specifies wavelength ranges reserved for additional service signals to be overlaid via wavelength division multiplexing (WDM) in future passive optical networks (PON) for maximizing the value of optical access networks.

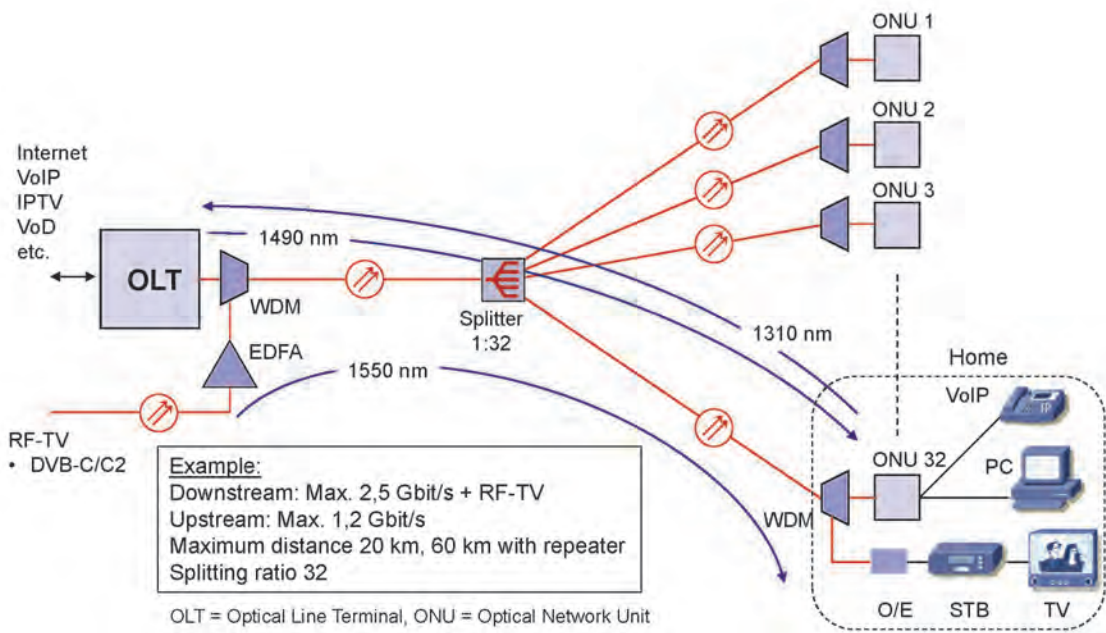

Figure 5.11. GPON with RF overlay.

The data link layer (layer 2 of the OSI model) of GPON network is called Transmission convergence layer, which is further divided into two sublayers: adaptation sublayer and framing sublayer. Transmission convergence layer generates and processes frames with duration of 125 μs. The payload of these frames consists of two sections, which are the following:

- A section consisting ATM cells of 53 bytes
- A section consisting GPON encapsulated frames. These frames may be (possibly split) Ethernet frames or e.g. SDH frames.

The adaptation and framing tasks of the transmission convergence layer are illustrated in figure 5.12. Transmission convergence layer is also responsible for tasks related to traffic control. For example it gives permissions (so called grants) to ONUs to send cells or frames.

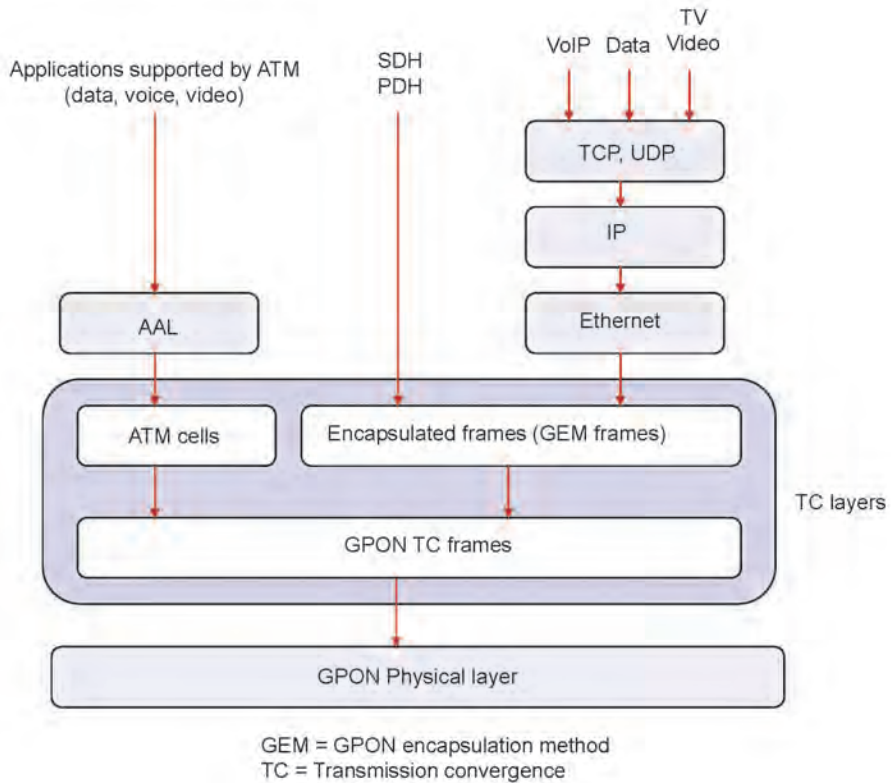

Figure 5.12. The principles of generation of GPON frames.

GPON supports in the WAN interface of OLT the following applications:

- SDH levels STM-1,4 ja16
- PDH levels E1, E2 and E3
- ATM
- Gigabit Ethernet with IP applications

In the ONU interface the following services are available:

- SDH levels STM-1 and 4
- PDH levels E1, E2 and E3
- ISDN BRI and PRI
- ATM
- Ethernet with IP applications (Internet, VoIP, IPTV, VoD etc.)
  - 10Base-T
  - 100Base-T
  - 1000Base-T

#### 5.4.2.2 XG-PON

The latest state of development of GPON-technology is XG-PON, which is specified in the recommendations of ITU-T G.987-series. In the designation XG-PON “X” stands for the Roman number 10, i.e., XG-PON means 10G-PON, which is the logical successor to GPON. The future complete ITU-T G.987-series will consist of XG-PON1 and XG-PON2. Specifications for XG-PON1 have already been published and transmission rates for XG-PON1 are 2,5 Gbit/s upstream

and 10 Gbit/s downstream. XG-PON2 specifications are still under development and they will include also 10 Gbit/s in downstream direction.

The main principle of XG-PON is same as in GPON. Transmission rates, however, are greater. Table 5.6 summarizes the main characteristics of XG-PON1. See also figure 5.14.

**Table 5.6.** Characteristics of the physical layer of XG-PON1.

Characteristics	Class N1	Class N2	Class E1	Class E2
<b>Fibre type</b>	Singlemode fibre IEC 60793-2-50 B1.1 or B1.3 (ITU-T G.652.D)			
<b>Number of fibres</b>	1			
<b>Transmission rate, downstream</b>	10 Gbit/s			
<b>Transmission rate, upstream</b>	2,5 Gbit/s			
<b>Wavelength, downstream</b>	1578 nm			
<b>Wavelength, upstream</b>	1270 nm			
<b>Maximum distance</b>	20/40 km			
<b>Maximum attenuation</b>	29 dB	31 dB	33 dB	35 dB
<b>Minimum attenuation</b>	14 dB	16 dB	18 dB	20 dB
<b>Split ratio</b>	Max. 64, determined by the attenuation budget.			
<b>Note:</b> Maximum distance (20/40 km) depends on the transmitter spectral characteristics. With reach extender the maximum distance can be extended up to 60 km.				

### 5.4.3 PON technologies specified by IEEE

#### 5.4.3.1 EPON or 1G-EPON

The passive optical network specified in the standard IEEE 802.3ah has been named Ethernet Passive Optical Network (EPON).

In the standard IEEE 802.3ah EPON is specified only for digital telecommunications and specifically for transmitting Ethernet frames. The physical fibre topology of EPON may, however, be used also for other applications, such as RF video transmission (e.g. television). The wavelength range 1550 – 1560 nm is used for this purpose.

An example of an EPON network is shown in figure 5.13. The figure shows the basic structure of 1G-EPON (IEEE 802.3ah) and it also shows the transmission rates, which are 1 Gbit/s in both directions. RF overlay is also included in the figure. The most important physical characteristics of EPON are shown in table 5.7. EPON with 1 Gbit/s transmission speed can also be called 1G-EPON. Also the name GEAPON seems to be used, but it is not recommended by IEEE and is not in accordance with the IEEE standard.

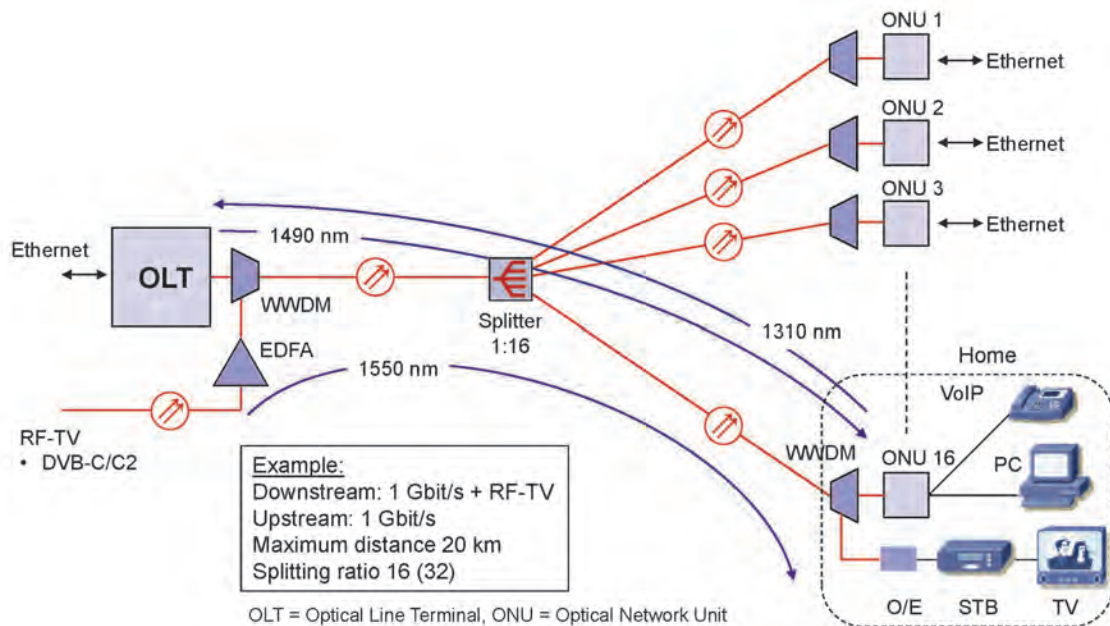

Figure 5.13. Basic structure of 1G-EPON network with RF overlay.

Table 5.7. Physical characteristics of 1G-EPON (IEEE 802.3ah).

Description	1000BASE-PX10-U	1000BASE-PX10-D	1000BASE-PX20-U	1000BASE-PX20-D
Fibre type	Singlemode fibre IEC 60793-2-50 B1.1 or B1.3 (ITU-T G.652.D)			
Number of fibres	1			
Transmission direction	Upstream	Downstream	Upstream	Downstream
Wavelength	1310 nm	1490 nm	1310 nm	1490 nm
Maximum distance	10 km		20 km	
Maximum attenuation	20 dB	19,5 dB	24 dB	23,5 dB
Minimum attenuation	5 dB		10 dB	
Split ratio	Max. 64, determined by the attenuation budget.			

As can be seen from table 5.7 EPON is based on one fibre transmission. The transmission rate in both directions is 1000 Mbit/s or 1 Gbit/s. Different wavelengths are used in the two directions. As in PON networks in general also in EPON network the equipment in the access node is called optical line terminal (OLT) and the customer terminal equipment is called optical network unit (ONU). A typical number of ONUs in an EPON network is 16, but the number may be even 32 if the attenuation specification of table 5.7 can be met.

The main strength of EPON is that it supports natively all Ethernet applications without protocol conversions or splitting frames and encapsulating them again (compare with BPON and GPON). Therefore it is very suitable technology for optical access networks and enables IP applications over Ethernet in an easy, flexible and cost effective way. Such IP applications are:

- Broadband Internet with associated applications and services
- IP telephone or Voice over IP (VoIP)

- IP television (IPTV) – the real digital television
- IP based video on demand services (VoD)

Being part of the IEEE 802 standard family EPON is also compatible with the following specifications:

- Classification and priority of services specified in the standard IEEE 802.1D
- Virtual Local Area Network (VLAN) specified in the standard IEEE 802.1Q

Classification of services is accomplished by using 3 bits priority information. With three bits 2<sup>3</sup> = 8 classes of services can be defined. In the standard IEEE 802.3D the classification and priority shown in table 5.8 is recommended.

**Table 5.8.** Priorities of services according to the standard IEEE 802.1D.

Priority	Priority bits	Service
Highest  ↓  Lowest	111	Network control and management, e.g.: SNMP, RIP
	110	Voice, e.g. VoIP
	101	Video, e.g. IPTV, VoD
	100	Controlled load
	011	Excellent effort, e.g. extranet
	000 (default)	Best effort, e.g. www
	010	Others
	001	Background

VLAN technology is used to create independent logical groups in the same physical network. These groups may be formed based on users, user groups, applications or equipment. In VLAN technology specified in the standard IEEE 802.1Q a 4 bytes VLAN field is added to the Ethernet frame. This field contains the 3 bits priority information described above and 12 bits VLAN identifier (VLAN ID). By using 12 bits VLAN identifier it is possible to define 2<sup>12</sup> = 4096 VLANs in one physical network.

VLANs operate just like separate local area networks and the unwanted traffic between VLANs is prevented. Thus the data security for different users and user groups is achieved. This is a very important aspect, because different kind of customers, such as households, companies and communities may be connected in the same physical network. Increasing outwork means that people are working more and more at home and the telecommunication between the home and the employing company is an essential part of the outwork.

#### 5.4.3.2 10G- EPON

The 1G-EPON standard IEEE 802.3ah was not the end point of the EPON technology development. In 2009 a new standard IEEE 802.3av was ratified and this standard specifies 10G-EPON, which is also fully compatible with the 1G-EPON.

10G-EPON is an EPON architecture operating at 10 Gbit/s in either downstream or both downstream and upstream directions. The following terms are used to describe the transmission rates in two directions: 10/1G-EPON and 10/10G-EPON.

The main physical characteristics of 10G-EPON are shown in table 5.9. The standard defines three optical power budgets that support split ratios of at least 1:16 and at least 1:32, and distances of at least 10 and at least 20 km. Figure 5.14 shows the wavelength allocation of 1G-EPON and 10G-EPON. Note that 1G-EPON uses the same wavelengths as GPON and 10G-EPON uses the same wavelengths as XG-PON.



**Table 5.9.** Physical characteristics of 10G EPON types 10GBASE-PR and 10/1GBASE-PRX (IEEE 802.3av).

Description	Low power budget		Medium power budget		High power budget	
	PRX10	PR10	PRX20	PR20	PRX30	PR30
Fibre type	Singlemode fibre IEC 60793-2-50 B1.1 or B1.3 (ITU-T G.652.D)					
Number of fibres	1					
Downstream rate	10 Gbit/s					
Upstream rate	1 Gbit/s	10 Gbit/s	1 Gbit/s	10 Gbit/s	1 Gbit/s	10 Gbit/s
Downstream wavelength	1578 nm					
Upstream wavelength	1310 nm	1270 nm	1310 nm	1270 nm	1310 nm	1270 nm
Maximum distance	10 km		20 km		20 km	
Maximum attenuation	20 dB		24 dB		29 dB	
Minimum attenuation	5 dB		10 dB		15 dB	

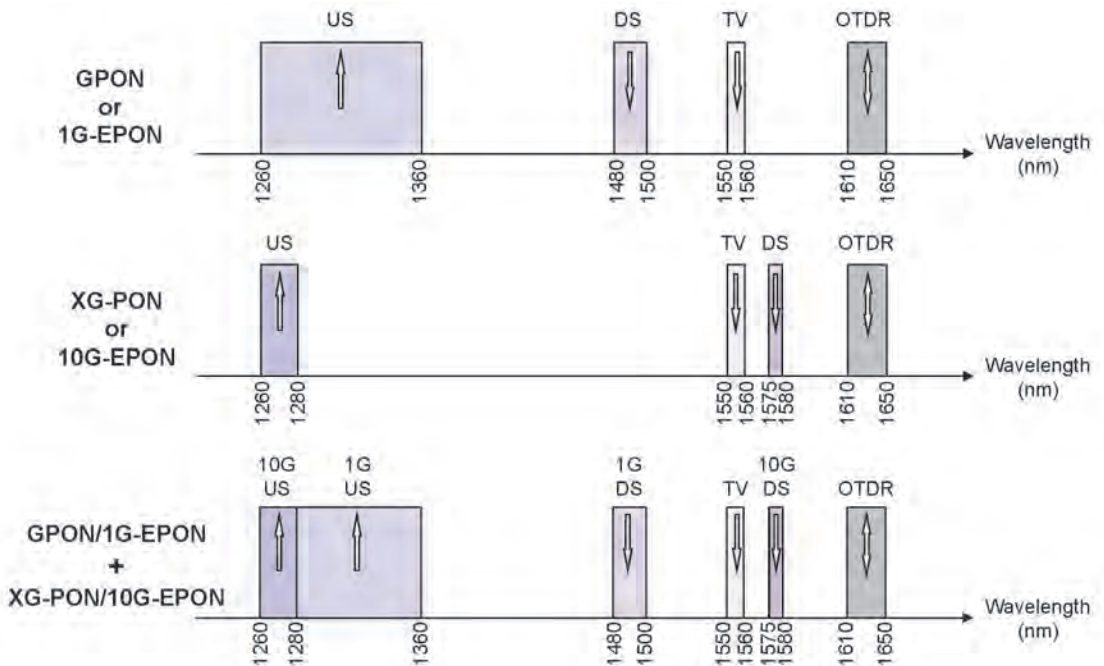

*Figure 5.14. Wavelength allocation of GPON or 1G-EPON, XG-PON or 10G-EPON and the co-existence of both 1G and 10G systems.*

An example of access with both 1G-EPON and 10G-EPON is shown in figure 5.15.

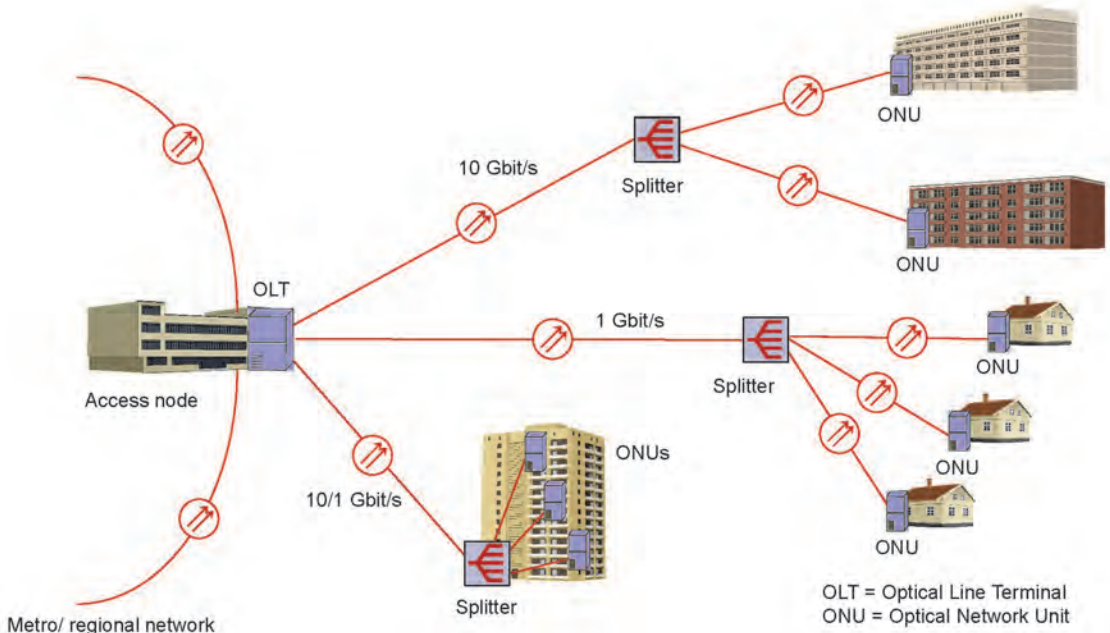
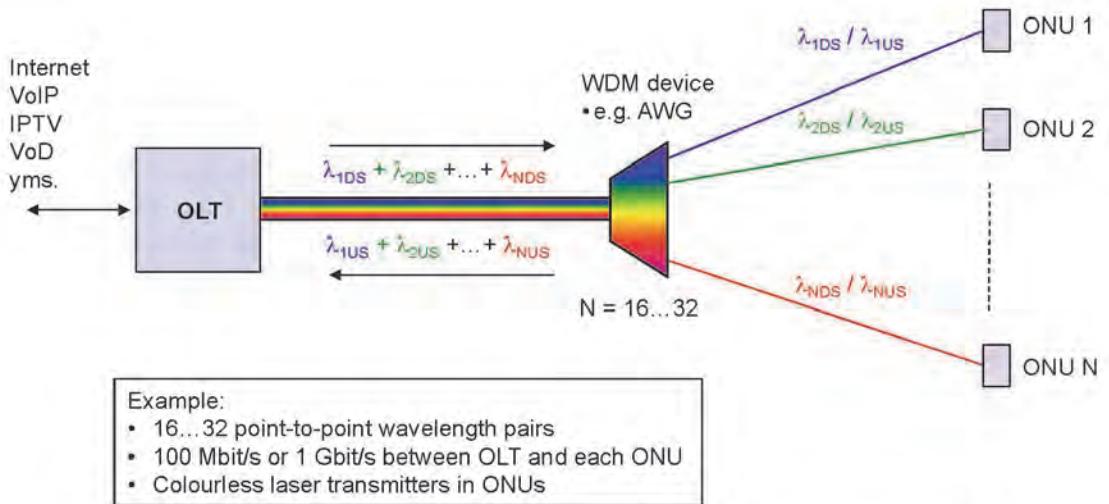

Figure 5.15. 1G-EPON and 10G-EPON in the same access network.

#### 5.4.4 WDM PON technologies

PON networks described in 5.4.2 and 5.4.3 are called TDM PON networks, because the capacity in upstream is managed by time division multiplexing. Another approach is to share the same physical fibre by using different wavelengths by using wavelengths division multiplexing (WDM). PON networks utilizing this technology are called WDM PON networks. The principle of a WDM PON network is shown in figure 5.16.



OLT = Optical Line Terminal, ONU = Optical Network Unit, AWG = Arrayed Waveguide Grating

Figure 5.16. WDM PON and its elements.

WDM PON networks are still at development stage and no standards exist. These networks, however, are very promising and they have some indisputable strengths and benefits. The main benefits are the following:

- Transparent end-to-end-solution from OLT to ONU and from ONU to OLT.
- Point-to-point wavelengths guarantee sufficient capacity and network security
- Different transmission rates and services are easy to be implemented and upgraded independently and without service interruption to other users.

The technology required for cost effective and reliable WDM PON is developing continuously and within few years WDM PON may be a very noteworthy alternative when decisions are made on access network technologies. Key components and topics related to WDM-PON are at least the following:

- Laser sources
  - Lasers with fixed wavelengths is an expensive solution, because several wavelengths are needed both in OLT and in ONUs.
  - Other solutions:
    - Broadband light source and sliced spectrum technology
    - Injection locked colourless laser
    - Reflective semiconductor amplifier
    - Tunable laser
- WDM-filter (mux/demux)
  - Thin film filter (TFF)
  - Fiber Bragg Grating (FGB)
  - Arrayed Waveguide Grating (AWG)
    - Promising technology, need further development
    - Temperature dependence; temperature control increases costs
    - Athermal AWG

The development from pure TDM PON to pure WDM PON will not happen directly. There will be a period of PON-technology, which can be characterized by a term hybrid TDM/WDM PON or TWDM PON. Figure 5.17 shows an example of TWDM PON, which consists of four “stacked” TDM PONs. Each TDM PON uses its own dedicated wavelengths.

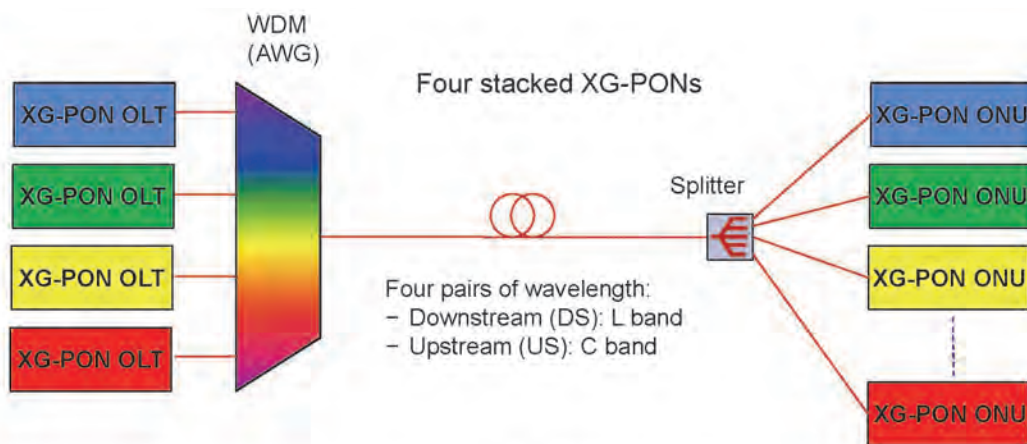

**TWDM PON**  
Time and Wavelength Division Multiplexed Passive Optical Network

*Figure 5.17. Example of 40 Gbit/s TWDM PON.*

ITU-T has published its first NG-PON2 specification in 2013 as Recommendation ITU-T G.989.1: 40-Gigabit-capable passive optical networks (NG-PON2): General requirements. This recommendation specifies the general requirements of TWDM PON technology, which supports 40 Gbit/s downstream capacity and 10 Gbit/s upstream capacity.

## 5.5 Active components used in optical networks

### 5.5.1 Transmitters

The function of a transmitter component is to convert the signal from electrical to optical form and to feed the signal into the optical fibre. Transmitter components used in optical fibre systems are based on semiconductor technology. The most important transmitter component types are:

- LED (Light Emitting Diode)
- VCSEL (Vertical Cavity Surface Emitting Laser)
- Laser (Light amplification by stimulated emission of radiation)

Among the three transmitter components listed above LED transmitters have lowest output power, widest spectrum and longest rise time. Therefore LED transmitters are used only in multimode fibre systems, such as optical building backbone cabling according to the standard EN 50173-1. Also in these applications the characteristics of LED transmitters are limiting factors, when Gigabit Ethernet or 10 Gbit/s Ethernet is used. The long rise times of LED transmitters limit the available transmission rate to 100 Mbit/s in Ethernet applications. Output power level of LED transmitters is typically -20 ...-5 dBm and the spectral width is 30... 100 nm. With LED transmitters the power coupled into the fibre depends very much on the ratio of the area and numerical apertures of the transmitter and the fibre core. If the radiation area and the numerical aperture of the LED transmitter are very much greater than those of the core area and numerical aperture of the multimode fibre, a great deal of the optical power is not coupled into the fibre. When using a LED transmitter it should always be known the power level which is coupled to the fibre type to be used.

VCSEL transmitters are used in local area networks using multimode fibres up to the transmission rate of 10 Gbit/s and up to the distance of 300 m. The category of the multimode fibre shall be OM3 or OM4 in accordance with EN 50173-1. The VCSEL transmitter is actually one type of laser transmitter, but it is much more cost effective than Fabry-Perot laser and DFB laser. The light beam of a VCSEL transmitter is much narrower than that of a LED transmitter, but it is wider than the light beam of the laser. This makes it very suitable to be used with multimode fibres. The refractive profile of a category OM3 and OM4 multimode fibres has been just optimized for this type of transmitter. Generally the operating wavelength of a VCSEL transmitter is 850 nm. The output power is typically 5... 10 dBm and the spectral width is < 1 nm. VCSEL transmitters with the operating wavelength of 1310 nm have also been developed, but they are not yet commercially competitive.

With singlemode fibres only laser transmitters are used. Therefore the laser transmitter is the most important transmitter type in optical access networks. Lasers may be divided into two main types:

- MLM laser (MLM = Multi-Longitudinal Mode), e.g. Fabry-Perot laser
- SLM laser (SLM = Single-Longitudinal Mode), e.g. DFB laser

The transmitted power spectrum of MLM laser consists of a group of spectral lines or wavelengths, which are distributed around the central wavelength. The typical spectral width is 3 nm. The spectral width of MLM laser is generally defined as the RMS value of the spectral distribution.

With SLM laser the transmitted power spectrum practically consists of only one narrow spectral line. The typical spectral width is << 1 nm. The spectral width definition of SLM laser is generally based on the -20 dB value.

Figure 5.18 illustrates the spectral characteristics of MLM and SLM laser.

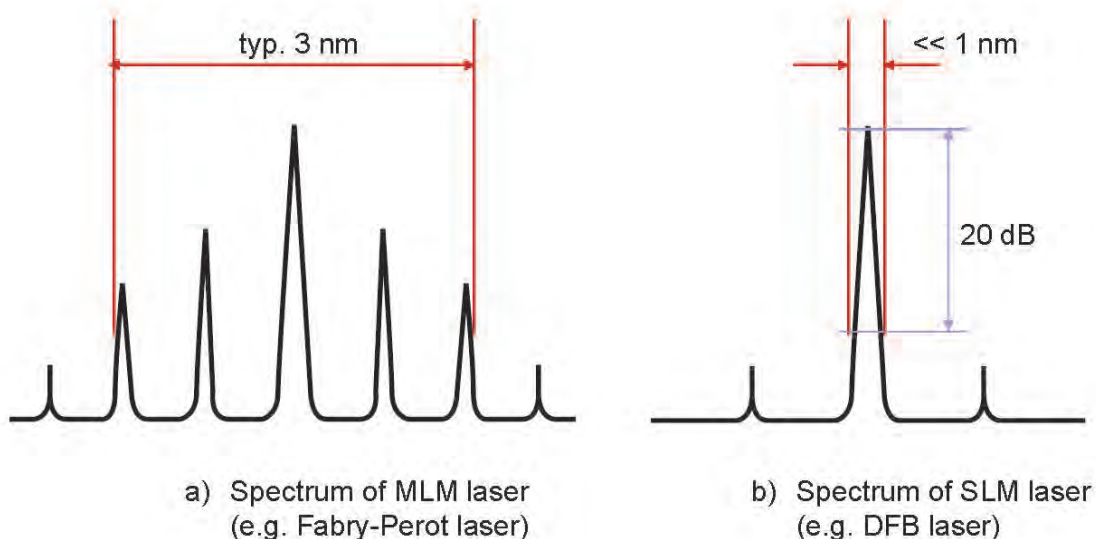

Figure 5.18. Spectral characteristics of MLM and SLM laser.

The transmitted power spectral width of a laser transmitter is an important factor, because it together with the dispersion characteristics of the fibre determines the reachable transmission distance with a certain transmission rate or the achievable transmission rate with a certain distance. The singlemode fibre (ITU-T G.652.D) used in optical access networks has a small dispersion within the 1310 nm window and a greater dispersion within the 1550 nm window. Therefore in PON technologies the downstream wavelength is 1480...1560 nm and the upstream wavelength is 1260...1360 nm. This makes it possible to provide ONUs with MLM lasers, which are cheaper than SLM lasers. Economically this significant, because, in one PON network there may be even 64 ONUs per one OLT. SML transmitters are used in OLTs. The detailed requirements of transmitters to be used in different types of PON networks are specified in the relevant ITU-T recommendations (GPON and XG-PON)) and in the relevant standards published by IEEE (1G-EPON and 10G-EPON). Output power of laser transmitters is typically 0...13 dBm.

The characteristics of lasers also depend on the temperature. The temperature dependence of the wavelength with MLM laser (e.g. Fabry-Perot) is typically 0,45 nm/K and with SML laser (e.g. DFB) it is typically 0,1 nm/K. The stability of wavelength is an especially critical factor, when CWDM or DWDM is used. In CWDM the interval between wavelengths is 20 nm and in DWDM it may be 0,8 nm, 0,4 nm, 0,2 nm or 0,1 nm.

### 5.5.2 Receivers

Detectors used in receivers are generally PIN diodes or avalanche photodiodes (APD). The detector converts the optical signal to electrical form for further processing of the signal. The most important characteristics of the receiver are the sensitivity and the dynamic range. The sensitivity means the lowest optical power level which can be detected with certain conditions (signal to noise ratio, bit error ratio). The sensitivity of a PIN detector is typically -55...-40 dBm and the sensitivity of an APD detector is typically -65...-40 dBm. The sensitivity depends on the transmission speed. The dynamic range means the power level range within which the detector operates adequately (linearity). If the dynamic range is too small, in short distances extra attenuators shall be used.

Figure 5.19 shows the typical required minimum input power of PIN diode and APD as the function of transmission rate. The power means the power representing the logical state "1" and the required bit error ratio is 10<sup>-12</sup>.



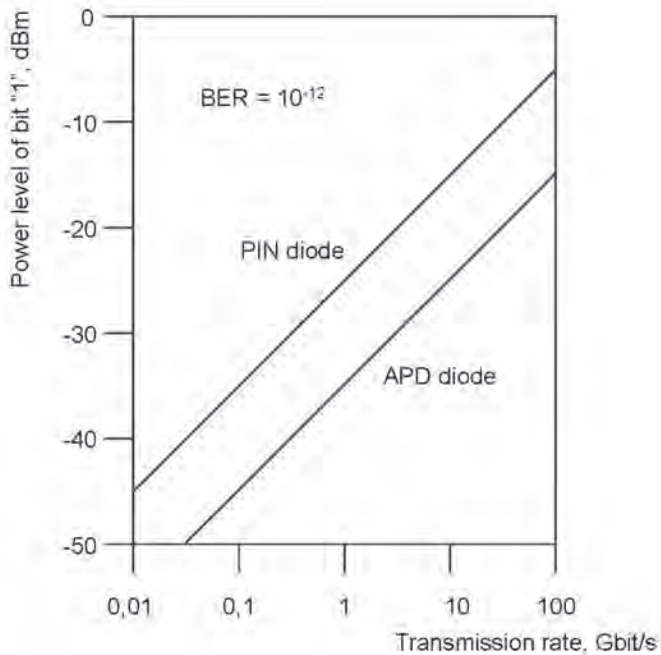

Figure 5.19. Typical minimum input power level (bit 1) of PIN diode and APD as the function of transmission rate. Bit error rate =  $10^{-12}$ .

### 5.5.3 Optical amplifier

The optical amplifier amplifies the signal directly in optical form without any conversion to electric and vice versa. Optical amplifiers are used to compensate the attenuation caused by long optical fibre links or several splitters. The most common applications are long submarine cable systems, long distance transmission links, cable television, optical access networks, OTDR applications and measurements of long fibres. Figure 5.20 illustrates the principle of an optical amplifier.

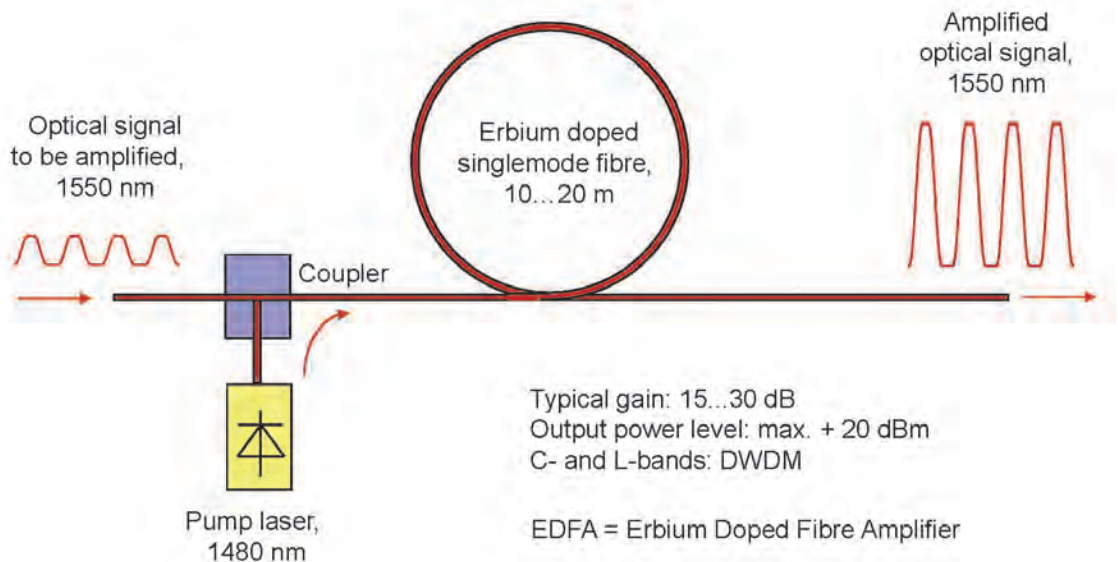

Figure 5.20. Principle of an optical amplifier.

The optical amplifier shown in figure 5.19 works with singlemode fibre and in the wavelength window 1550 nm (1530...1565 nm). The main components are pump laser, combiner and erbium doped singlemode fibre with length of 10...20 m. The optical power of the pump laser is fed to the erbium doped fibre with length of 10...20 m by using the combiner. The wavelength of the pump laser is typically 1480 nm. This optical power excites the atoms of the erbium doped fibre to higher energy level. This excited condition, however, is not stable and the atoms are relaxed immediately causing emission at the optical wavelength of 1550 nm. This results in amplification the optical input signal. The gain of the optical amplifier depends on the input level and slightly on the wavelength. The typical gain is 15...30 dB and the output power may be even 20 dBm. An optical amplifier with more than one output can be implemented by integration of an optical splitter with the amplifier. Figure 5.21 shows an example of a multiport optical amplifier.



Figure 5.21. Example of a multiport optical amplifier (Alloptic).

## 6 Planning of optical access network

The previous chapters of this book have dealt with components of optical access networks and transmission systems with different topologies. The purpose of network planning is to make choices and decisions on principles and practices, which are used to construct a working and reliable network of components and active equipment in such a way that the network serves the specified and future purposes in an optimal way.

The infrastructure of the optical access network is in key position regarding the availability, ability to serve and lifetime of the network to be constructed. It also constitutes the major part of the network investments. Therefore in this book planning is mainly limited to planning of the infrastructure of the optical access network. In this book the infrastructure means the installed structure and configuration of passive components, such as cables, cable terminations and cable joints.

The infrastructure also includes all mechanical constructions required for the installation, pathways and other constructions, which are needed considering other use of installation environment.

### 6.1 Structure and functional elements of optical access network

Optical access network is an access network, which consists of optical fibre cables and other optical fibre components and which extends from the access node to the optical termination point at the customer premises. The access node is typically located in teleoperator's equipment room and the customer termination point is typically located in the building distributor.

The following installation methods may be used when constructing an optical access network:

- Installation into duct systems or underground pipes (duct installation)
  - Traditional installation in ducts
  - Installation into microducts
- Installation directly in the ground (direct burial) e.g. by ploughing
- Installation on poles (aerial installation)
- Installation along the bottom of the sea, lake or river (underwater installation)

The cable route may include straight cable joints and/or branching joints. Straight cable joints are needed, because the cables have limited manufacturing lengths and also for other technical reasons it is not often possible to install the whole cable route by using one long continuous cable. These joints are implemented by using joint closures, which are located in manholes, handholes, directly underground or on poles depending on the installation method of the cable. Branching joints are used for branching a part of the fibres of the bigger cable to one or more smaller cables. Branching joints may be implemented by using joint closures, but using joint cabinets gives more flexibility and enables a better maintainability in situations, where the number of branches is great and may increase in future.

Each cable section is terminated at both ends to a patch panel, a termination box or other termination point. Teleoperator's distributor or building distributor of commercial building may consist of a big optical distribution frames (ODF). The building distributor of a multi-storey residential building/multi dwelling unit is typically provided with wall mounted termination box or patch panel installed in rack or cabinet. In a single-family house there is a small building/home distributor cabinet with an optical termination or a termination box with integrated ONU. The optical access network may also include intermediate distributors, such as primary and secondary distributors, which may be also called curb distributors, campus distributors, village distributors, etc.

Figure 6.1 illustrates the structure and functional elements of the optical access network as well as the installation methods of cables.

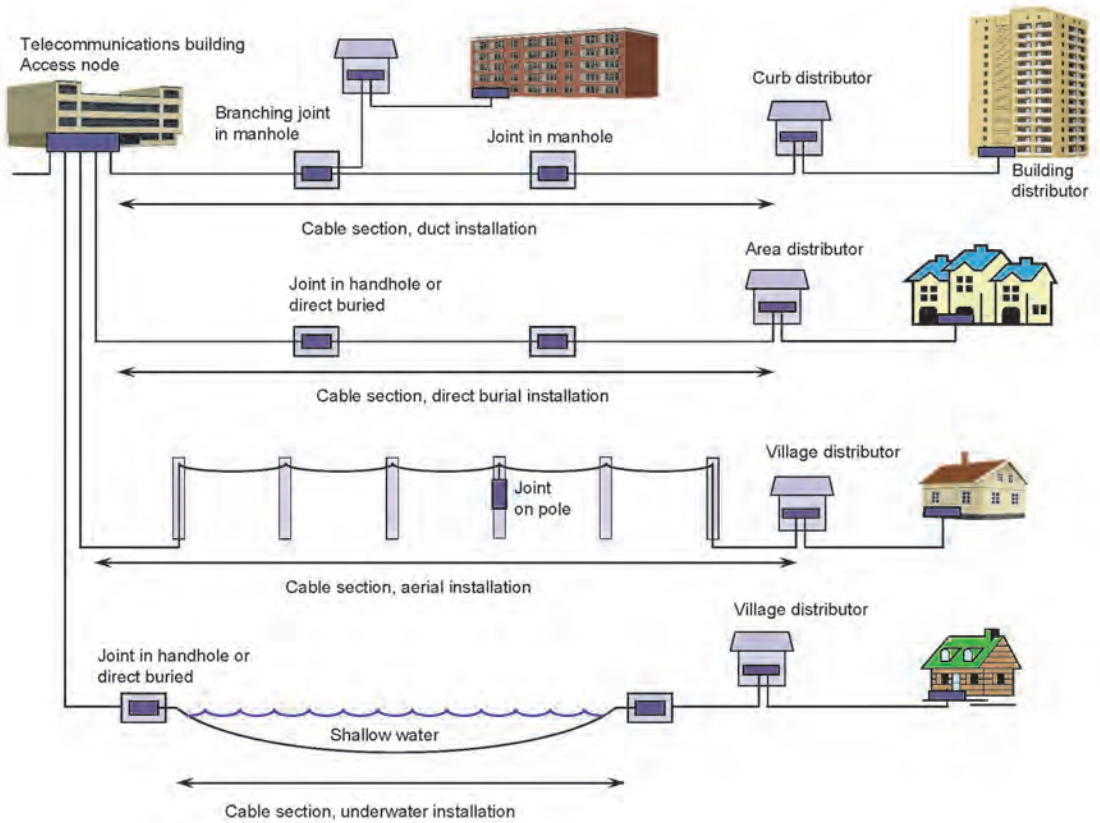

Figure 6.1. Structure and functional elements of the optical access network with different installation methods.

In addition to cables, distributors and joints a great number of installation accessories, protective and supporting constructions and other arrangements are included in the infrastructure. These are needed to ensure a reliable network and for taking into account the other use of the installation environment, such as electric power lines, roads and streets, railways, rivers and lakes. When the network is installed, cables are also installed in road and street areas and in areas, which are property of different landowners or estate owners. Crossings of roads, railways, waterways, power lines, other telecommunication lines, gas lines, heat lines etc. are also inevitable.

Planning of cable routes and locations of distributors shall also take into account the maximum link lengths, which are supported by the intended present and future telecommunications applications. The structure of the network should be future proof and flexible for changes and extensions.

## 6.2 Tasks and importance of planning

Planning of optical access network means considering all the aspects described in clause 6.1 and making choices between different alternatives. The most important tasks of planning can be listed as follows:

- Planning of network topology and fibre counts based on initial data, which has been gathered for planning.
- Choosing the installation methods of cables, planning of cable routing and taking into account other use of the installation environment.
- Specification and selection of components to be used.
- Planning of locations and implementations of joints and distributors.

- Making attenuation calculations to ensure the performance.
- Preparing the planning documents.

The owner of the network may plan the network with his own resources or he may use services of a company, which has special knowledge in planning of networks. Using own resources requires, however, sufficient knowledge and resources and therefore in many cases services of a specialized company may be a reasonable solution. In some cases, however, it may be more advantageous to carry out the planning activities within the owner of the network, because this enables more flexible and rapid changes in plans.

The required permissions to install cables should be applied as early as the plan and the project schedule have been completed. Permissions may be needed from the following persons, communities, authorities and administrations:

- Landowners and estate owners
- Road administration
- Railway administration
- Municipalities and cities

### 6.3 Physical topology and numbers of fibres

#### 6.3.1 Physical topology – open infrastructure

The topologies of optical access networks presented in chapter 5 are logical topologies, which describe the logical connections of the data traffic. Regarding the network infrastructure (physical network) the essential topologies, however, are the fibre and the cable topologies. Figure 6.2 shows the same networks as in the figure 5.6, but now the fibre topologies are shown.

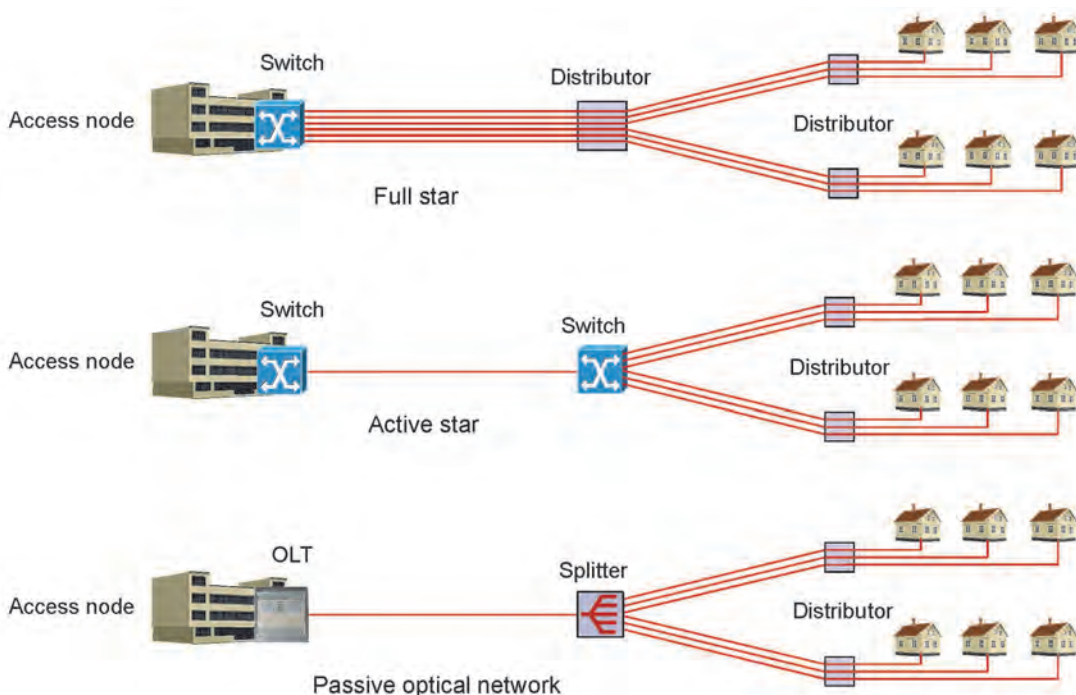

NOTE: Distributor = Branching joint (fusion splices) or crossconnect (connectors) .

Figure 6.2. Three fibre topologies of the access network.



The physical network should have a long lifetime and it should support a great number of transmission systems with different logical topologies. Therefore the planning of the physical topology cannot be based on only one certain transmission system and on its typical logical topology.

The basis for planning the physical topology includes the following principles:

- The network infrastructure with its physical fibre and cable topology shall support both active point-to-point and passive point-to-multipoint access networks.
- The transmission links of the network shall have performance, which supports telecommunications applications as long in future as possible.
- The access capacity of the network (e.g. number of fibres/customer) shall be great enough to support various services and the technological alternatives to implement these services.
- The physical network shall enable easy installation of equipment required by various services and the spaces, environments and other conditions for this equipment shall be appropriate and meet the relevant requirements.

Figure 6.3 shows an example of a physical cable topology, which supports all the logical topologies shown in figures 6.2. It also supports many other logical topologies of optical access networks.

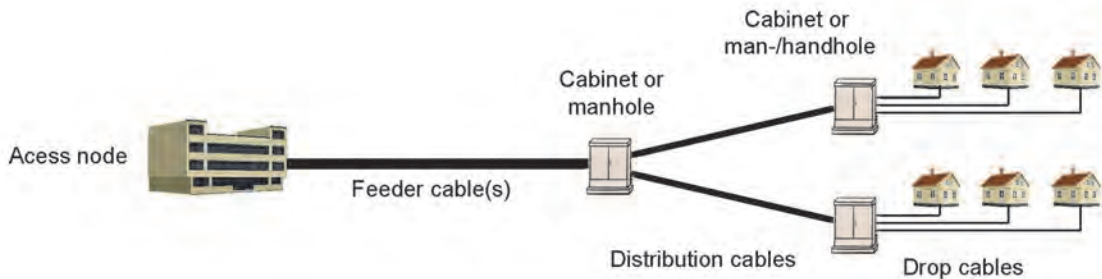

*Figure 6.3. Example of a physical cable topology, which supports a great number of transmission systems and logical topologies.*

The cabling topology shown in figure 6.3 is tree topology. When sufficient fibre counts are used in different sections of the network, this topology enables to choose whatever fibre topology in the same physical network. Also several fibre topologies may be implemented simultaneously.

### 6.3.2 Reference model, planning principles and numbers of fibres

The reference model of optical access network is shown in figure 6.4. This model is based on the principles of sub-clause 6.3.1 and it takes into account different types of housing structures and population distribution patterns. The reference model of figure 6.4 shows the total structure of the access network. Each network level and each element shown in the figure may not exist in all practical implementations of optical access networks.

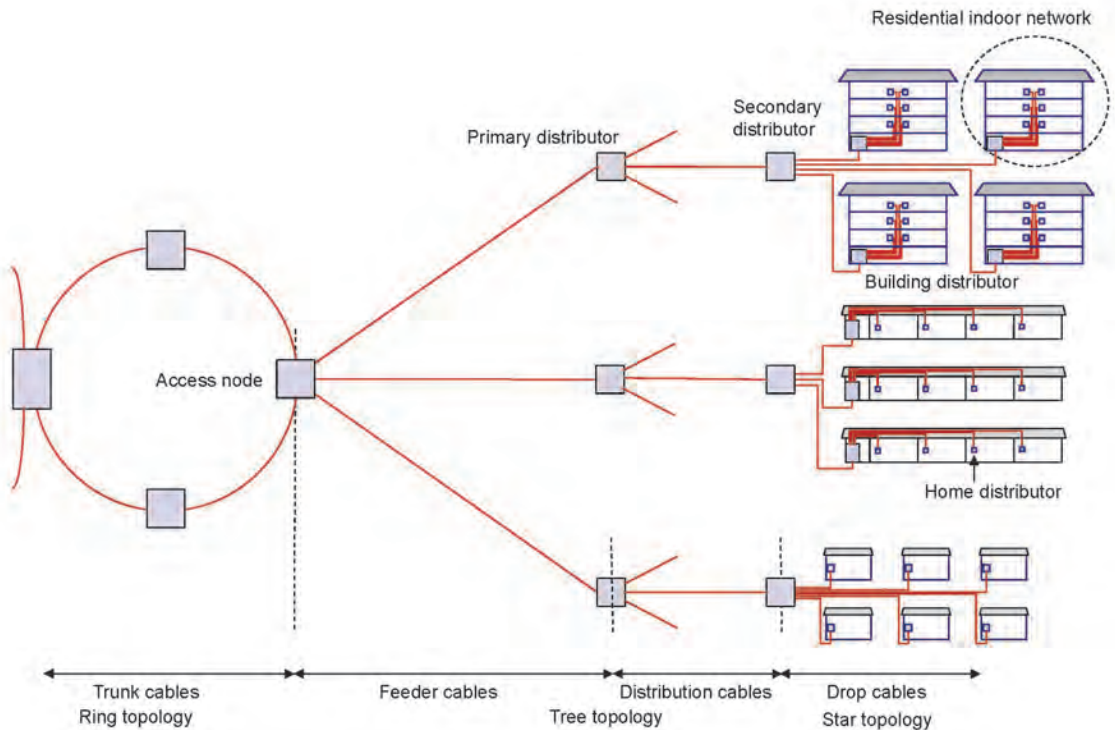

Figure 6.4. Reference model of optical access network.

The network structure and its physical topology shown in figure 6.4 are based on the following principles:

- The network consists of cable sections, which have optical fibre cable termination at both ends. The cable termination may be in the teleoperator's distributor (central office/equipment room or curb distributor), in building distributor of a building, in outdoor distributor or it may be a termination box.
- The optical fibres of the network follow star topology with respect to each distributor or termination point. The optical fibre cable section may include straight joints or branching joints. Therefore the cable topology is not necessarily the same as the fibre topology.
- Numbers of fibres within different cable sections are chosen to support various telecommunications applications considering also the future. Cables with less than 4 fibres are not recommended.
- The equipment (e.g. repeater, amplifier, switch, splitter, WDM) required by the transmission system are located only in distributors (indoor or outdoor distributor) or in other termination points. The conditions of rooms, spaces, cabinets etc., shall meet the relevant requirements specified for equipment (temperature, humidity, cleanliness etc.).

As stated in chapter 5 most transmission systems of the optical access network require maximum 2 fibre and most also work with only one fibre. More fibres should, however, be reserved in the cables to ensure easy changes, extensions and security/backup. The extra fibres in the cable do not essentially increase the construction costs of the network. Based on these principles the numbers of fibres shown in table 6.1 are recommended. The recommendations of table 6.1 also take into account the fact that the numbers of fibres in the cables generally are multiples of number 6.

The names feeder cable, distribution cable and drop cable are used in table 6.1. These are shown in figure 6.4 and are defined as follows:

- Drop cable is the access network cable, which has been terminated to the building distributor.

It is the last cable section before the customer termination.

- Distribution cable is the access network cable, which has been terminated to the distributor, from which the drop cable sections begins. This distributor may be a curb distributor, village distributor, campus distributor or any other local distributor). The interface between the feeder cable and the drop cables may be implemented with a branching joint or with cross connections.
- Feeder cable is the access network cable which extends from the access node to the distributor, from which the distribution cable sections begins. This distributor may be a curb distributor, village distributor, campus distributor or any other local distributor). The interface between the feeder cable and the distribution cables may be implemented with a branching joint or with cross connections.

**Table 6.1.** Recommended minimum numbers of fibres in optical access network. N = number of buildings served by a feeder cable.

Type of building	Cable section	Number of fibre in the cable
Single-family house	Drop cable	4 or 6
	Distribution cable	$2 \times N + 24$
	Feeder cable	$2 \times N + 48$
Row house	Drop cable	24
	Distribution cable	$6 \times N$ , min. 24
	Feeder cable	$6 \times N$ , min. 48
Multi dwelling unit (MDU) (multi storey building)	Drop cable	24
	Distribution cable	$6 \times N$ , min. 24
	Feeder cable	$6 \times N$ , min. 48
Commercial or office building	Drop cable	24
	Distribution cable	$6 \times N$ , min. 24
	Feeder cable	$6 \times N$ , min. 48

In addition to table 6.1 it should be noticed that a full FTTH implementation in multidwelling units (MDU) and row houses requires the following numbers of fibres:

- Drop cable:  $2 \times H + 12$
- Distribution cable:  $2 \times H + 6 \times N$
- Feeder cable:  $2 \times H + 6 \times N$

H = number of households (apartments) served by the cable

N = number of buildings served by the cable

### 6.3.3 Maintenance aspects

In the planning phase many such important decisions are made, which have a great influence on the future development and related costs of the network. Therefore the maintenance aspects of the network during its whole lifetime should be taken into account already in the planning phase.

It should be also noticed that the costs of the planning are minimal, but its influence on the maintenance and operating costs may be very great. Most essential aspects are listed in the following:

- Appropriate material selection
- Not too many different material types
- Qualified installation

- Adequate documentation of the network
- Appropriate system and equipment solutions
- To be prepared for changes

During the lifetime of the network need of changes may be caused by:

- Increasing number of subscribers
- Growth of the network coverage area
- Changes in the structure of the network
- Fault cases in the physical network

Changes can be taken into account in advance by the following:

- Reserve ducting
  - Reserve cable ducts in main routes
  - Reserve microducts in microduct bundles
- Additional reserve routes by looping
- Reserve capacity in branching joints and distributors
  - Joint closures with several extra cable entries
  - Use of joint cabinets
  - Use of cross connections on distributors
- Reserve cable loops for possible branching points

The maintenance aspects listed above should be considered sufficiently already in the planning phase of the network. These aspects have a certain influence also on the component selection.

#### 6.3.4 Location of splitters and splitter implementations in PON network

One special question in planning of PON network is the location of splitter. The location of splitter has an effect on construction and maintenance costs of the network and therefore it requires an attention.

The splitters in PON network may be located in two principal ways: centralized or distributed. Centralized location means that there is only one splitter or splitter assembly in the network. This splitter may be e.g. a splitter with splitting ratio of 1:32 and it may be located at the distance of few kilometres from OLT and with distances of a few hundreds of meters to ONUs. Distributed location means that there are several splitters in different points of the network. These splitters have smaller splitting ratio, but the total splitting ratio of all splitters may e.g. 1:32.

In the case of centralized location the splitter or splitter assembly is located in an optimal point of the network regarding the costs and maintenance aspects. This point may be one of the following:

- Access node. The splitter is connected directly to the output of OLT. In this case the network will have the full star fibre topology. This alternative is suitable for the cases, where the distances from OLT to ONUs are short.
- Curb distributor, village distributor or other local distributor located at relatively short distance of from customers. This alternative is suitable for the cases, where the distance from OLT to the service area of PON is longer than a few hundreds of meters. In this case the splitter may also be located in the branching joint within the joint cabinet. The joint cabinet enables a much better maintainability and extendibility than a joint box. An underground joint box is not a recommendable location for the splitter.
- Building distributor of multi-storey building or row house. The principle in this case is that one or more PON network serve one building or building complex. This alternative is very useful, if the building is provided with optical fibre building backbone cabling.

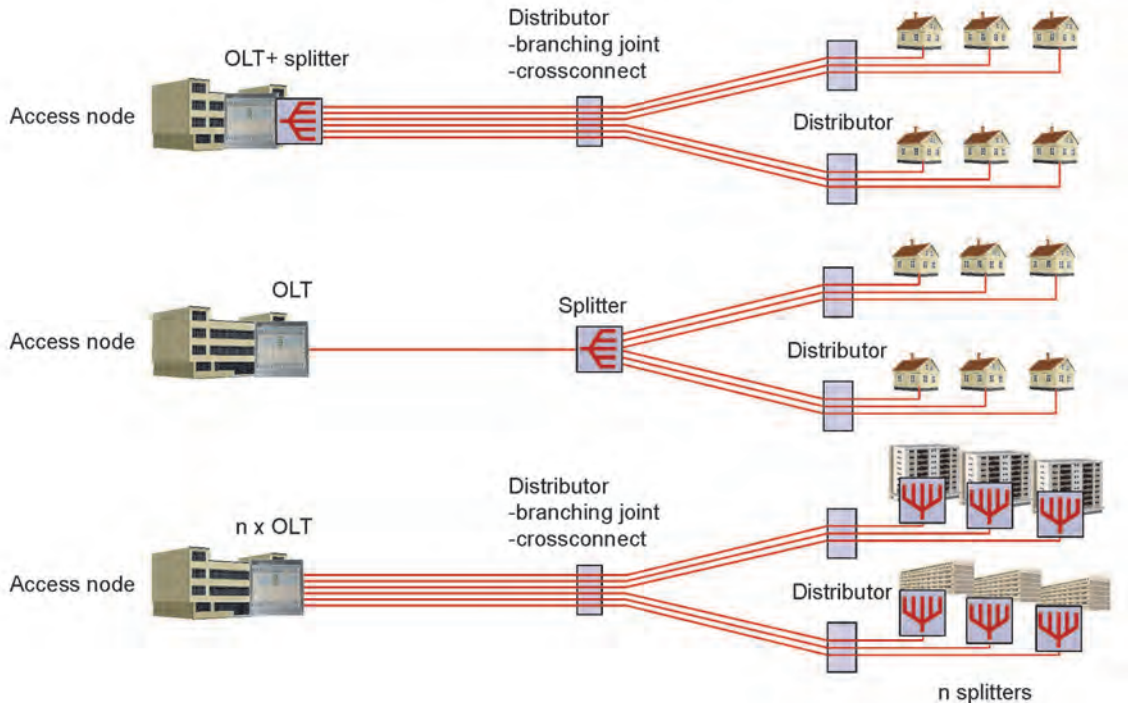

Figure 6.5. Location alternatives of splitters in PON networks.

The principles stated above are only general guidelines. The location of splitter shall be carefully planned in each case considering the locations and distribution of buildings, distances, geography, future needs and of course also the costs. More guidelines can be found in the recommendation ITU-T L.52.

It should be noticed that a splitter, although being passive, is an application specific component and in this respect it can be compared with active equipment, such as switch. Therefore it is recommended to use splitters, which are mounted in a closure, such as panel with connectors. Connectorized panels with in-built splitters can be mounted in racks and cabinets. Use of these kind connectorized panel type splitters enables clear interfaces in the network for testing needed in maintenance and operation. The connector type in splitter panels should be APC polished SC or LC connector. APC polished connector gives a great return loss (< 55 dB) also in the unmated state (see sub-clause 4.1 and figure 4.3).

### 6.3.5 Space and housing for access node

The active equipment of the optical access network is located in access nodes. The space and housing of the access node may be situated in a building of the teleoperator in other premises. The access node may also be situated in its own small building or even in an outdoor cabinet.

The main alternatives for an access node housing and space are the following:

- A new small building for access node
  - Requires piece of land (site), road access and building licence
- Hired space or housing
  - Availability may difficult or even impossible, especially in new areas
- Outdoor cabinet
  - No special piece of land (site), road access and building licence are required



- May be vulnerable: traffic, vandalism

The most important planning aspects for access nodes are:

- Location and its environment
- Physical dimensions of the space
- Construction and physical protection
- Equipment (active and passive) to be installed in the space
- Environmental conditions required by the active equipment
- Power supply
- Air conditioning and heating
- Cabling into the space and within the space

## 6.4 Choosing criteria and specification of components

The components of optical access network have an essential effect on the performance, quality and lifetime of the network. Component choice and specification together constitute one of the main tasks of planning.

The most important components of the optical access network are the following:

- Optical fibre cables and the optical fibres
- Optical fibre connectors, fibre pigtails and patch cords
- Splitters, WDM components and other passive optical components
- Optical fibre termination boxes, patch panels, distributor mechanics and joint accessories

It is strongly recommended that a specification is drafted and all the essential requirements of components are specified in this specification. The specification is a very useful tool in purchase of network components and it can be used to ensure the performance and quality of components.

### 6.4.1 Optical fibre cables and optical fibres

The characteristics of optical fibre cables have been described in chapter 3 of this book. Choosing criteria and recommendations for cables can be found in that chapter. The following summarizes the most important choosing criteria and items to be specified:

1. The recommended fibre type in the cable of optical access network is the singlemode fibre in accordance with the recommendation ITU-T G.652.D. This is the so called low water peak singlemode fibre. This fibre has been specified also by IEC and the relevant and equivalent IEC fibre type is IEC 60793-2: B1.3.
2. The recommended numbers of fibres are those shown in table 6.1.
3. The construction and the materials of the cable shall be compatible with the installation environment and the installation method:
  - Outdoor installation:
    - Duct installation including microduct installation
    - Direct burial installation
    - Aerial installation
    - Underwater installation
  - Indoor installation
4. The mechanical and environmental characteristics of the cables shall be specified. Some essential tests are described in clause 3.3 of this book. At least the following test requirements should be specified:
  - Tension

- Crush
  - Impact
  - Bending
  - Temperature cycling
  - Water penetration
5. The cable manufacturer or supplier should give information of the following installation characteristics of the cable:
- Minimum bending radius
    - During pulling, when the cable is subject to simultaneous tension and bending
    - Final bending (static condition)
  - Minimum installation temperature
  - Maximum pulling force
  - Crush strength

#### 6.4.2 Optical fibre connectors, fibre pigtails and patch cords

The characteristics of optical fibre connectors have been described in clause 4.1 of this book. Choosing criteria and recommendations for cables can be found in that clause. The following summarizes the most important choosing criteria and items to be specified:

1. The recommended connector types are SC and LC
2. The recommended polishing grade is APC, which gives return loss of more than 60 dB.
3. The following characteristics should be specified in the purchase specification (recommendation in brackets):
  - insertion loss:  $\leq 0,25$  dB
  - return loss:  $\geq 60$  dB (APC)
  - stability: change of insertion loss  $\leq 0,2$  dB
  - repeatability:  $\geq 500$  connections
  - ferrule polishing: radius of curvature 5...12 mm (APC); apex offset  $\leq 50$   $\mu\text{m}$ ; fibre undercut/protrusion  $\leq 0,05$   $\mu\text{m}$
  - ferrule material: ceramic (zirconium oxide)
  - alignment sleeve of adapter: ceramic (zirconium oxide)
  - colour of connector body: SM/APC – green.
  - of connector body (SM/APC – green)
4. The operating temperature range of optical fibre connector (and other passive components) depends on its environmental category. See table 4.3. In outdoor distributors category O is the minimum requirement.
5. The following characteristics of fibre pigtails and patch cords should be specified in the purchase specification:
  - Fibre type and types of coating
  - Connector type, both ends for patch cords
  - Length

#### 6.4.3 Splitters

The characteristics of splitters have been described in clause 4.2 of this book. Choosing criteria and recommendations for cables can be found in that clause. Specifications can be also found in

the recommendation ITU-T G.671. The following summarizes the most important choosing criteria and items to be specified:

1. The construction and environmental characteristics of the splitter shall be specified considering the location and installation method of the splitter. Possible locations are indoor or outdoor distributors and joint cabinets. Factory made panels with splitters inside and with APC polished connectors are strongly recommended whenever this is possible in the network.
2. Splitting loss of splitter may form a major part of the attenuation budget. This shall be taken into account when specifying the splitting ratio.
3. The following characteristics should be specified in the purchase specification (recommendation in brackets):
  - Splitting loss (depends on splitting ratio)
  - Return loss:  $\geq 40$  dB for splitter component;  $\geq 60$  dB mated and  $\geq 55$  dB unmated for panel type connectorized splitters
  - Wavelength range: all wavelengths used in PON and cable TV (including RFOG) systems
  - Directivity:  $\geq 50$  dB

#### 6.4.4 Optical fibre termination boxes, patch panels, distributor mechanics and joint accessories

The characteristics of optical fibre termination boxes, patch panels, distributor mechanics and joint accessories have been described in clauses 4.3.1 and 4.3.2 of this book. Choosing criteria and recommendations for cables can be found in those clauses. The following summarizes the most important choosing criteria and items to be specified:

1. Termination boxes are recommended to be used when the number of fibres to be terminated is small (4...12...24) and when it is not possible to mount termination point in 19" rack.
2. For higher fibre counts and with racks use of 24 or 48 fibre patch panels is recommended.
3. Joint boxes are most suitable for straight cable joints, which are used to extend the cable route or to change the cable type from outdoor cable to indoor cable. Joint boxes can be used also for cable branching purposes.
4. Joint cabinets are most suitable in situations, where e.g. the feeder cable is jointed with several drop cables with different directions. Using joint cabinets gives more flexibility for changes and extensions and enables a better maintainability.
5. Specification of optical fibre termination boxes, patch panels, distributor mechanics and joint accessories with numerical performance characteristics is not possible in the same way as with cables, fibres and connectors, but their constructional and functional requirements can be specified based on information given in clauses 4.3.1...4.3.3.

#### 6.5 Attenuation calculations

For transmission systems the maximum allowed attenuation between the transmitter and the receiver is specified. This so called attenuation budget includes the sum of all attenuation factors, which may appear in the certain optical access network section between the transmitter and the receiver. These factors are the following:

- Total attenuation of optical fibre. This depends of the attenuation coefficient of the fibre (dB/km) at different wavelengths and on the total length of the fibre (km).
- Total splice loss. This depends on the individual splice loss (dB) and on the total number of fibre splices.
- Total connector loss. This depends on the insertion loss of an individual connection (dB) and on the total number of connections.
- Splitter loss (e.g. in PON network and in cable television network). This depends on the splitting ratio. Splitter loss increases by app. 3,5 dB each time, when the split is doubled.

Taking into account the above mentioned factors it is easy to understand that the available maximum attenuation or attenuation budget sets limits to both the link length and the splitting ratio. It should

be noticed that in PON networks and in cable television networks the splitting loss is the greatest individual attenuation factor and it may represent more than half of the attenuation budget. Just only splitting into two (1:2) results in the same attenuation as app. 10 km of singlemode fibre at wavelength 1310 nm.

The other limiting factor for optical transmission link length and also for transmission rate is the dispersion. In optical access networks the length calculations, however, can be made based on attenuation budget. The link lengths for transmission systems used in optical access network are such that the attenuation is the first limiting factor, not the dispersion.

Attenuation calculations are required to ensure that the total attenuation of each transmission link is not more than the maximum allowed attenuation. These calculations shall be made in the planning stage of the optical access network. The same calculation may include also the dispersion calculation. Information of the total dispersion may be useful in future, when new applications are taken into use.

Figure 6.6 shows an example of a link or section with total length of 5 km and with 6 connections made by connectors, 5 fibre splices and one splitter. The connectorized panel type splitter is located in a local distributor (e.g. in curb distributor or in village distributor) and its splitting ratio is 1:32.

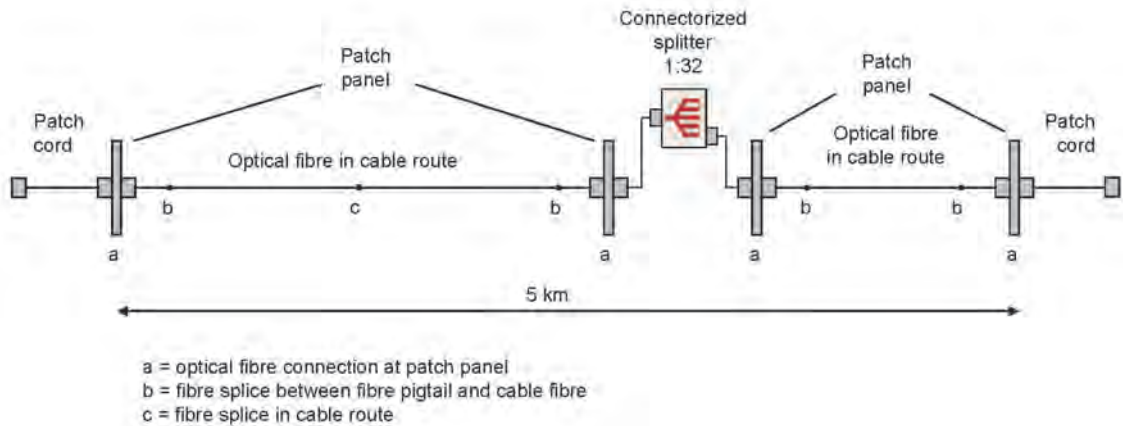

Figure 6.6. Example of attenuation factors of a link. Attenuation calculation of this link is shown in table 6.2.

The attenuation calculation for the link shown in figure 6.6 is presented in table 6.2. In this case the planning criterion for the physical network attenuation has been the target that the network shall support GPON with attenuation class B and with splitting ratio of 1:32. Therefore the maximum allowed attenuation is 25 dB at wavelengths 1310 nm and 1490 nm.

It can be seen from table 6.2 that the splitting loss 17,5 dB is more than half of the whole attenuation budget (25 dB). If 1:32-splitter would be changed to 1:64-splitter, the splitting loss would increase to 21 dB. This would cause exceeding the attenuation budget. If the link length is reduced to less than 1,5 km, then the budget allows use of 1:64-splitter. Attenuation calculations can be easily made based on the example of table 6.2 and using Excel spreadsheet software. Proving of different alternatives is also easy with these tools.

It is important that all the real attenuation factors are taken into account in the calculations. For example the total splice loss shall include all splices of fibre pigtails in termination points – not only the fibre splices within the route.

Safety margin and repair splice margin are factors, which shall also be included in the calculation. Ageing phenomena of equipment increase of splice losses (for some reason) and possible

additional repair splices are taken into account with these factors.

**Table 6.2.** Example of attenuation calculation.

<b>Attenuation calculation</b>				
<b>Link: Access node - Building distributor</b>				
Fibre type: ITU-T G.652.D		Unit	Wavelength	
			1310 nm	1550 nm
1.	Fibre attenuation coefficient	dB/km	0,40	0,25
2.	Chromatic dispersion coefficient	ps/nm*km	3,50	18,00
3.	Link length	km	5,00	5,00
4.	Total fibre attenuation	dB	2,00	1,25
5.	Average splice loss	dB	0,10	0,10
6.	Number of splices	pc.	5	5
7.	Total splice loss	dB	0,50	0,50
8.	Repair splice loss	dB	1,00	1,00
9.	Average insertion loss of connection	dB	0,30	0,30
10.	Number of connections	pc.	6	6
11.	Total connector loss	dB	1,80	1,80
12.	Splitting loss, 1:32	dB	17,50	17,50
<b>13.</b>	<b>Total attenuation of link</b>	<b>dB</b>	<b>22,80</b>	<b>22,05</b>
<b>14.</b>	<b>Maximum allowed attenuation</b>	<b>dB</b>	<b>25,00</b>	<b>25,00</b>
<b>15.</b>	<b>Attenuation margin</b>	<b>dB</b>	<b>2,20</b>	<b>2,95</b>
<b>16.</b>	<b>Total dispersion of link</b>	<b>ps/nm</b>	<b>17,50</b>	<b>90,00</b>

## 6.6 Planning documents

The planning documents are the results of the planning process. The planning documents include all the essential drawings and descriptions which are needed in the construction and building of the optical access network. Depending on the project the planning phase may be divided into drafting phase, preliminary implementation phase and the implementation phase. The documents required for the implementation phase are discussed in the following.

The most important documents of implementation phase are the following:

- Route plan
- Installation specification

The route plan includes the description of the route and the route drawing on the map base. The description includes the following information for each route:

- Total length
- Itemization of duct cable, direct burial cable, aerial cable and underwater cable sections with lengths
- locations of distributors and equipment rooms/spaces
- Numbers of fibres of the cables

The description is complemented by the route drawing on the map base. The above mentioned information is also included in this drawing. The scale of the map is chosen appropriately and it



may be e.g. 1:20 000 ... 1:10 000.

Installation methods and working practices are specified and described in the installation specification. It includes guidelines and requirements which are addressed to both civil works contractors and telecommunications contractors. At least the following essential items should be specified in the installation specification:

- Installation characteristics of materials to be used (ducts, cables etc.).
- Instructions for duct and/or cable ploughing
- Installation instructions of cables; e.g. pulling or blowing
- Refilling and surface finishing after installation
- Cable entrance into the building
- Installation of cable joints (manholes, cabinets, poles etc.)
- Crossing of roads and railways, passing of bridges
- Installation instructions for aerial cables
- Markings and labels
- Documentation requirements

## 6.7 Customer premises networks

As can be seen in figure 6.4 also the customer premises networks are technically part of the access network. The administration and the possession principles of the customer networks differ from country to country, but in each case there is a technical interface between the external optical access network and the customer premises network. This interface is commonly located in the building distributor of the premises.

In this book we discuss only those customer premises networks which serve residential premises. The customer premises networks of commercial or office buildings are not discussed. These networks follow the European standard series EN 50173. Quite a lot of literature, such as articles and books, has been published about these well standardized networks.

There are also two European standards, which specify FTTH supporting optical fibre cabling in multi-subscriber premises. These standards are:

- EN 50700: Information technology - Premises distribution access network (PDAN) cabling to support deployment of optical broadband networks.
- ETSI TS 101 573: Access, Terminals, Transmission and Multiplexing (ATTM); General engineering of optical building cabling.

EN 50700 has been prepared and approved by CENELEC and it has been written from the viewing angle of the premises owner (as also in EN 50173 series). ETSI TS 101 573 has been prepared and approved by ETSI and it represents more the viewing angle of access operators.

The following cabling principles are only for guidance and help to understand the variety of cabling models, which can be used in residential premises. The examples do not strictly follow any standard.

### 6.7.1 Optical fibre cabling within dwelling units (MDU)

The small size and a great variety of cable constructions have made it possible to implement the optical fibre cabling in MDUs in several alternative ways. The planner of the network should consider these alternatives and choose the optical solution for each case separately i.e. case by case. Four alternative cabling solutions are described in the following.

The conventional cabling solution is shown in figure 6.7. In this solution one optical fibre cable (typically 4 fibres) is installed from the building distributor to each home or apartment. In the

building distributor this cable is terminated to an optical patch panel or termination box. In homes the cable is terminated to the termination box of the home distributor. The optical fibre connector type is SC or LC.

This direct cabling to homes is a very simple and clear featured solution. It requires, however, the appropriate pathways both in its vertical and horizontal sections. Fibre termination work in homes can be avoided if factory connectorized optical fibres are used.

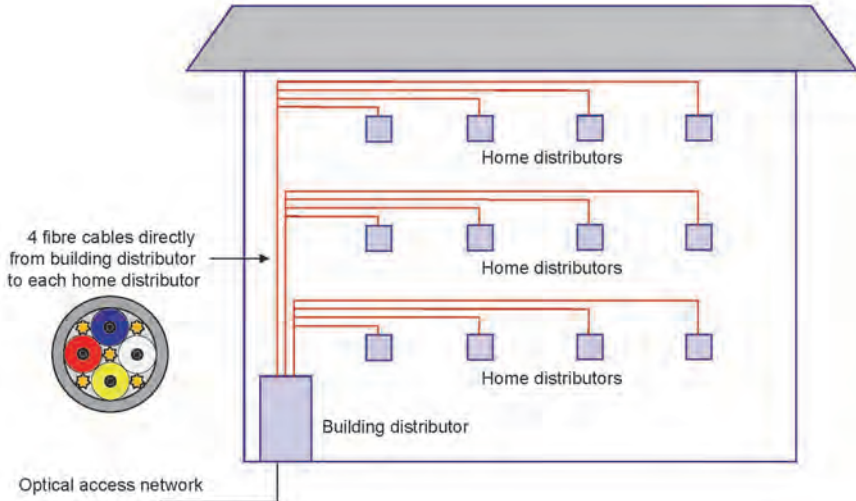

Figure 6.7. Direct cabling from building distributor to homes.

The cabling solution of figure 6.8 shows the second cabling alternative. In this case the cabling consists of two different sections: building backbone cabling and horizontal cabling. One optical fibre cable is installed from the building distributor to each floor. The fibre count of each backbone cable is typically  $n \times 4$ , where  $n$  is the number of homes on the floor. Each floor is provided with a floor distributor closure. The fibres of the building backbone cable are spliced to the fibres of the horizontal cables within the floor distribution closure. The backbone cables are terminated in the building distributor to an optical patch panel or termination box and the horizontal cables are terminated in homes to the termination box of the home distributor. The optical fibre connector type is SC or LC.

In this solutions the backbone cables and horizontal cables may be installed separately and at different stages. Fibre termination work in homes can be avoided if factory connectorized optical fibres are used. Floor distributor and fibre splices within it are, however, are required on each floor.

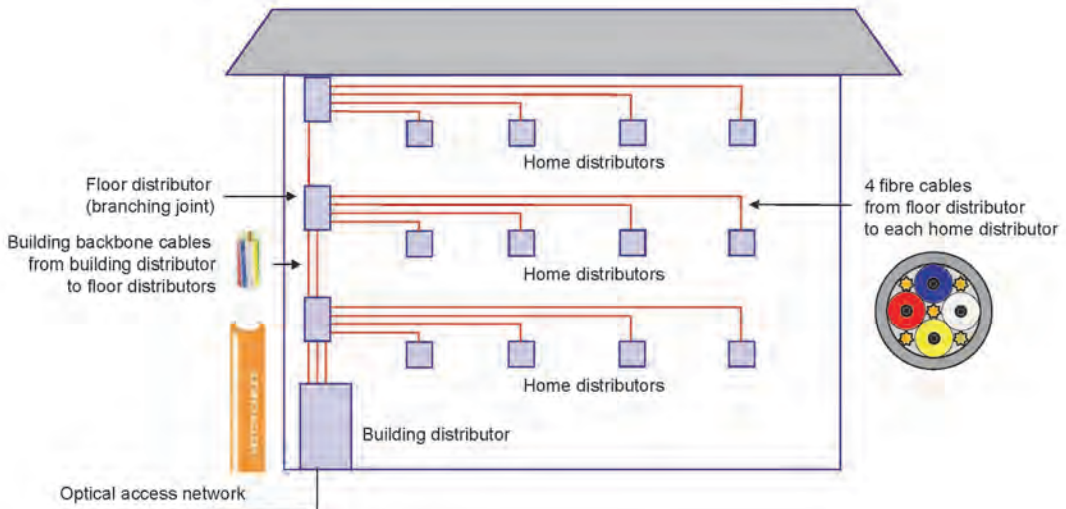

Figure 6.8. Cabling consisting of separate backbone cabling and horizontal cabling.

The third cabling alternative is shown in figure 6.9. It may be considered as some kind of modification of the previous alternative. In this case there is only one common building backbone cable with sufficient number of fibres. This cable is installed from the building distributor to the uppermost floor of the building. The fibre count of this cable is typically  $4 \times n$ , where  $n$  is the total number of homes to be served by this backbone cable. The construction of the cable shall also be such that enables the mid span access of the fibres. Stranded loose tube cable construction is the most suitable construction to fulfil this requirement. During the installation of the building backbone cable a loop with excess cable length is created on each floor. The cable length of this loop should be app. 2 m. In the mid span access the cable sheath is removed for a certain length and only one or more fibre tube or fibre group are cut for branching purposes. The whole cable is not cut and most of the fibres are continuing to the next floor. On each floor the required number of fibres is spliced to the horizontal cables as in previous alternative. The fibre splices and extra loops are located on the floor distributor closure on each floor. The common backbone cable is terminated in the building distributor to an optical patch panel or termination box and the horizontal cables are terminated in homes to the termination box of the home distributor. The optical fibre connector type is SC or LC.

In this third cabling solution alternative the building backbone cable may be installed at one stage from the building distributor to the uppermost floor distributor. Horizontal cabling on each floor can be installed independently and at different stages. The home connections may even be made one by one, whenever needed. Fibre termination work in homes can be avoided if factory connectorized optical fibres are used. Floor distributor and fibre splices within it are, however, required on each floor.

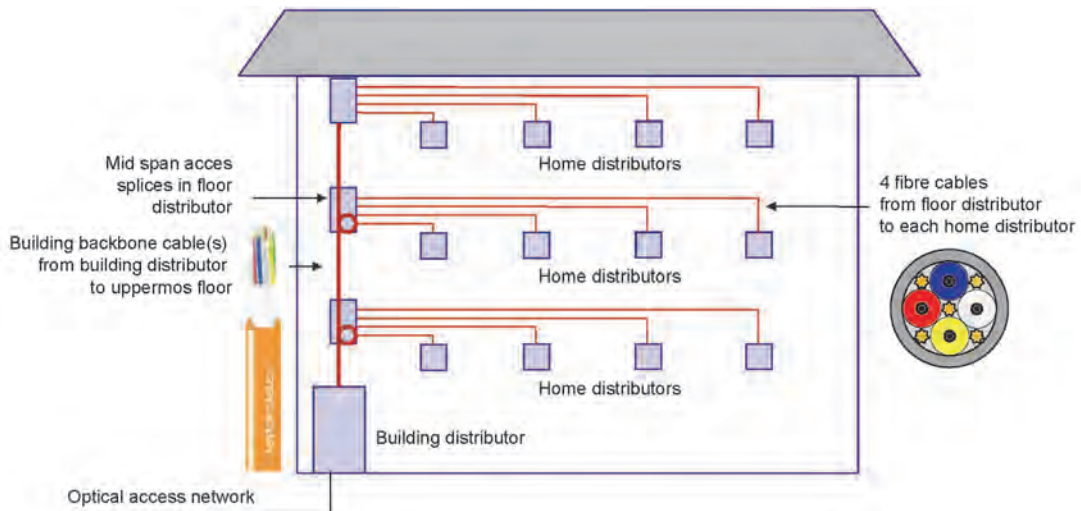

Figure 6.9. One common backbone cable with mid span access on each floor.

Microducts and blown fibre is the fourth alternative of cabling. The principle is this solution shown in figure 6.10. The microduct is installed from the building distributor to each home or apartment. Afterwards the fibres may be blown whenever needed. There several microduct and blown fibre systems on the market.

This solution enables the fibre installation from building distributor to the home whenever and without any disturbance to other homes and building services. If the fibres are blown from the home to the building distributor, pre-connectorized fibres can be used and no termination work is needed in homes. In the building distributor the fibres are terminated to an optical patch panel or termination box. The optical fibre connector type is SC or LC.

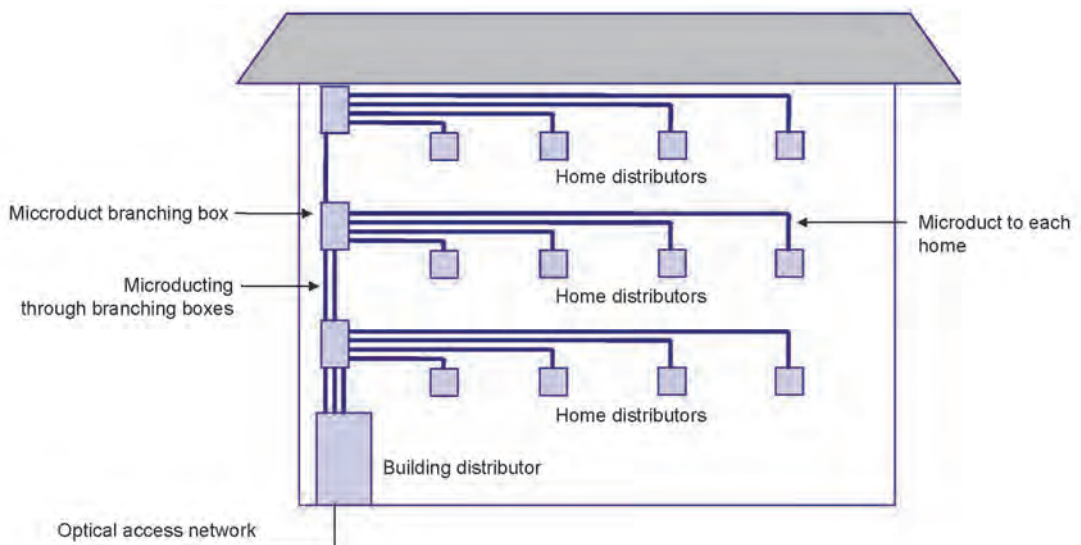

Figure 6.10. Microducting and future blown fibre.





## 7 Installation of optical fibre cable

### 7.1 Handling of cable

The purpose of the cable construction is to protect fibres during manufacture, transport, storage, installation and use. During all these stages the cable is subject to various stresses, such as mechanical stresses, temperature, humidity, sunlight etc. The cable should function reliably in the environment for which it is designed and intended to use. Therefore it is important to know and follow the rules of handling and installation of cables. It is also important to take into account all the conditions of installation and use. The cable construction depends on the installation method and the installation environment. The structures and materials of cables are chosen in such a way that the cable will maintain the specified transmission characteristics for its whole lifetime provided that handling and installation are done according to the given installation instructions.

#### 7.1.1 Transport and storage of cables

Cable drums should always be transported in a vertical position. In a vertical drum the spooling layers will keep their positions and unreeling can be carried out without problems. To prevent the loosening of the cable the drum shall be moved by rolling it in the direction shown by an arrow in its flange. The drum shall be lifted to and from a vehicle by using a crane or forklift. Dropping of the drum may cause damage to the cable and the drum. During transport the drum should be fastened to the transport base in order to prevent its movements. Impacts and pushes to the drum should be avoided. The protective battens or papers should be kept in place until the moment of installation. Short and small cables delivered in coils are transported and stored in a horizontal position and on an even base. Sharp bends in coiled cables should be avoided.

Indoor storage of cables is recommended. In outdoor storage the cables should be protected from direct sunlight and continuous humidity. It is very important to protect the cable ends in order to keep moisture away from cables. Heat shrinkable protective cap is the best way for this.

#### 7.1.2 Unreeling from drum or coil

Before unreeling the cable from the drum the location of the drum shall be chosen so that pulling of the cable is possible without mechanical damage to the cable. The drum is lifted on the jack stand or drum dolly, where it can rotate. The cable is unreeled from the top of the drum by rotating the drum and not only by pulling the cable. The rotating of the drum should be controlled in order to avoid loosening of the cable. If the cable gets too much loose the layers may get in disorder and extra loops may be resulted. This increases the risk of damage to the cable.

Pulling from a coil is carried out by holding the coil in vertical position and rotating it with hands. If the cable is pulled directly from the coil there is a danger of torsion (see figure 7.1). Some coil packages, however, allow direct pulling of cable. This shall always be checked before installation.

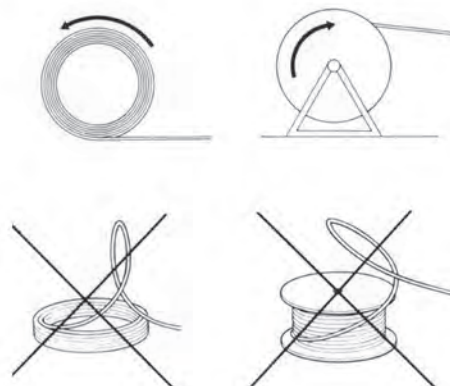

Figure 7.1. Unreeling from coil and drum.

### 7.1.2 Handling of cables during installation

In all stages of installation it is important to follow the installation instructions and limiting values given by the manufacturer. During pulling, splicing and termination care should be taken that the fibre shall not be subject to any tensile, crush or bend stresses which may damage it or degrade its optical characteristics. A possible damage caused by installation may show itself even long time after installation. The most important limiting values for installation are the following:

- Minimum bending radius
- Minimum installation temperature
- Maximum pulling force
- Crush strength

Typical installation characteristics of optical fibre cables are shown in table 7.1.

**Table 7.1.** Typical installation characteristics of optical fibre cables.

Characteristic	Indoor cables	Outdoor cables
Maximum pulling force	1-fibre cable: 100 N 2-fibre cable: 200 N Other cables: 500...750 N	Underground and duct cables: 1200...3000 N Armoured underground cables: 5000...8000 N Aerial cables: 6000...10000 N
Crush strength		
-plate 100 mm	2000 N	4000...8000 N
-mandrel 25 mm	1000 N	1000...2000 N
Minimum bending radius		
-during pulling	1- and 2-fibre cable: 40 mm Other cables: 20...30 × D	20...30 × D
-final bending	1- and 2-fibre cable: 30 mm Other cables: 15 × D	15 × D
Minimum installation temperature	-5 ...0 °C	-15 °C
<p><b>Note 1:</b> D = outer diameter of cable  <b>Note 2:</b> Bending radius of an indoor cable with bending loss insensitive singlemode fibres (ITU-T G.657) may be smaller. Manufacturers' instructions shall be followed.</p>		

The minimum bending radius is defined in order to prevent damage of cable structure during bending. Too sharp bending may cause sheath break and cable kink. Excessive bending causes excess loss for fibres and in worst case even breaking of fibres. The minimum bending radius is usually given for two situations:

- During pulling (simultaneous bending and pulling)
- In final bending (static condition)

The minimum bending radius in final bending is smaller than during pulling. The limiting value depends on the cable construction and they are given by the manufacturer for each cable type.

The minimum installation temperature is determined by the cold strength of plastics and other organic materials used in the cable. In low temperatures plastic materials become harder and more vulnerable to mechanical damage, such as cracking and breaking.

The minimum installation temperature always means the temperature of the cable, not the

environment. If the cable has to be installed at a lower temperature or its temperature has decreased in outdoor storage, it should be moved into a warm place enough in time before installation. The temperature of the cable in the drum increases slowly. The time needed for this may be from some hours up to 20 hours. The time depends on the size of drum, length and type of cable and temperature difference. The unreeled cable gets cooler quickly and therefore the installation should be done without any delay. Typical values for the minimum installation temperature are -15 °C for outdoor cables and -5 °C for indoor cables.

The maximum pulling force is determined by the strength elements of the fibre optic cable. Fibres do not stand mechanical strain and therefore the pulling force shall not be applied to fibres. The pulling force shall be applied evenly to the strength elements according to the instructions given by the manufacturer. Use of pulling heads is recommended. Pulling heads can be installed in cables already in the factory. The maximum pulling force depends on the cable construction and it is given by the manufacturer for each cable type. The limiting values are defined in such a way that a fibre will not be subject to strain which may damage or degrade it. The maximum pulling length of the fibre optic cable in e.g. duct installation can be calculated when the maximum pulling force, weight of cable and coefficient of friction are known. An optimal installation method in this sense is blowing of cable into the tube.

The crush strength is important, because an excessive crush causes damage to cable structures. Especially underground cables may subject to great crush forces during installation and use. An excessive crush to fibres causes stresses and microbendings, which decrease the lifetime of the fibre and increase losses. The crush strength of the cable depends on the cable construction and it is given by the manufacturer for each cable type. The crush strength is expressed as the force with which the cable is pressed by using a plate or a mandrel against the base plate. The length of the plate is 100 mm and the diameter of the mandrel is 25 mm.

During all stages of handling and installation care should be taken in order to avoid the following situations:

- Excessive crush
- Pressing onto sharp edges and angles
- Impacts and twitches in cable
- Rubbing against sharp edges, rough surfaces etc.
- Excessive torsion of cable
- Extra loops in the cable

## 7.2 Installation practices of cables

The installation methods of outdoor cables are the following:

- Duct installation
  - Conventional duct installation into duct system or into underground pipes
  - Air blowing of microduct cables into microducts
- Direct burial installation (underground installation): installation directly to ground with ploughing or digging
- Aerial installation: installation on poles
- Underwater installation: installation along the bottom of sea, lake or river

### 7.2.1 Conventional installation in duct by pulling

In duct installation the cable is installed into duct system, which consists of duct pipes and manholes. Duct pipes form especially in cities, towns and other urban areas large systems (figure 7.2). The outer diameter of the duct pipe is typically 100 mm or 50 mm. Duct systems generally

run under pavements or green areas and only exceptionally under driveways. At the manhole the duct systems may have branches to different directions and the manholes also provide points for jointing and maintenance activities. Installation of duct pipes is shown in figure 7.3.

A lighter alternative to the actual duct installation is installation into underground pipes. This practice is suitable in rural areas and areas where no duct systems exist and where they are neither needed. Underground pipes are installed into ground (soil) in the same way as direct burial cables (see clause 7.2.3). If the soil does not allow ploughing, a digging machine is used. Typical diameter of a pipe which can be ploughed is 40 mm.

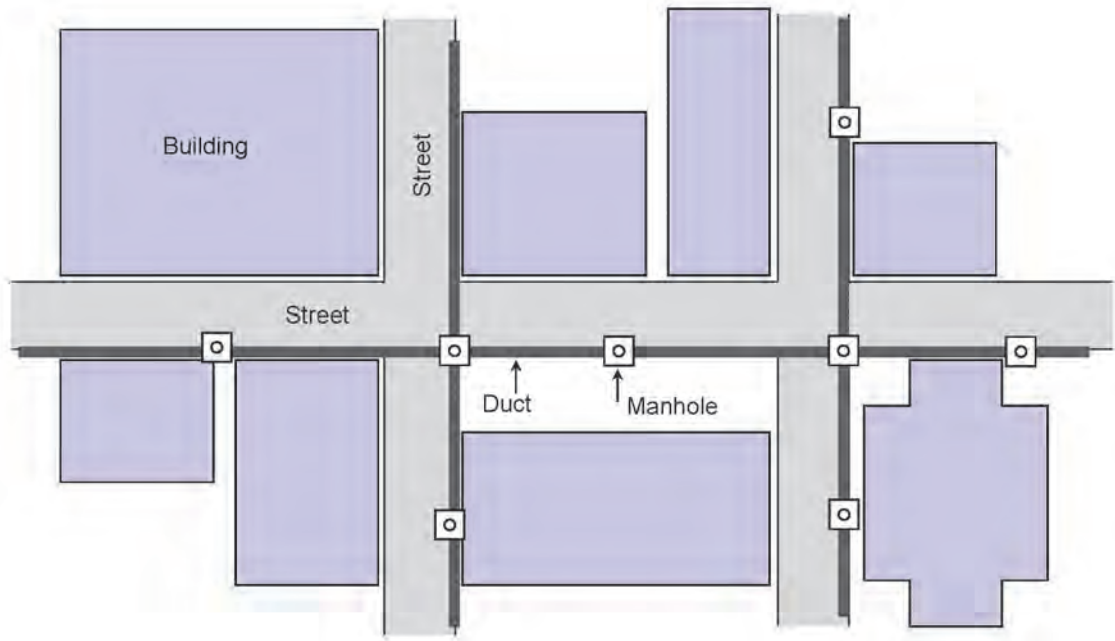

Figure 7.2. Principle of duct system in an urban area.



Figure 7.3. Installation of duct system.

In duct installation the duct pipes provide the cables with a well-controlled protection and the cables are not subject to high mechanical stresses during normal operation. Therefore duct cables generally have a lighter construction than underground (direct burial) cables. Duct cables should, however, have a design and structure which gives sufficient protection to the fibres during installation and use in duct systems. Duct cables generally have plastic sheath with longitudinally overlapped laminated aluminium or steel tape. In the case of steel tape the tape is corrugated. During the recent years duct cables without metallic laminate in the sheath have become more and more common. Such cables can well be used for duct installation, provided that they have sufficient tensile strength, strong sheath and proper water blocking to prevent the humidity and water penetration.

In pulling of the cable it is recommended to use a pulling head, in which the pulling rope is attached. Pulling heads can be installed in cables already in the factory. In manholes the cable should be guided in such a way that it is not rubbed against the edges of duct pipe openings and is not damaged. The pulling length can be increased by using intermediate pulling points. During pulling the pulling force shall be controlled and the maximum pulling force shall not be exceeded. Also the other limiting values of installation shall be followed.

It should be noticed that a cable with a smaller weight can be pulled into the duct with a smaller force than a cable with a greater weight. The pulling force needed is directly proportional to the weight of the cable.

The maximum pulling length can be calculated with the following formula:

$$L_{\max} = \frac{F_{\text{allowed}}}{\mu \cdot G} ,$$

- where  $L_{\max}$  is the maximum allowed pulling length, km
- $F_{\text{allowed}}$  is the maximum allowed pulling force of the cable, N
- $\mu$  is the coefficient of friction
- $G$  is the weight of the cable, N/km

The following values can be used for the coefficient of friction  $\mu$ :

Unknown conditions	1,0
Concrete pipe	0,9
PE sheathed cable into PVC pipe	0,3...0,5
Pulling rolls in direct burial	0,2...0,3

*Example:* Cable is pulled into PVC pipe ( $\mu = 0,4$ ).  
 Maximum allowed pulling force of the cable  $F_{\text{allowed}} = 2500$  N.  
 Weight of the cable = 175 kg/km = 1720 N/km.  
 Hence  $L_{\max} = 2500 / ( 0,4 \cdot 1720 ) = 3,634$  km



### 7.2.2 Installation of cable in duct by air blowing

An optical fibre cable can be installed into the duct system or into the underground pipe also by using compressed. This installation technique is called blowing technique. The principle of cable blowing technique is shown in figure 7.4. The compressor feeds pressurized air to the pipe and this blowing air makes also the cable to move in the pipe. The interaction between cable sheath and the blowing air is so great that generally no piston is needed at the end of the cable. A piston may be, however, needed for flexible cables and for cables with very small diameter especially when the cable diameter is very small compared with the pipe diameter. An optimal situation is that the inner diameter of the pipe is two times that of the outer diameter of the cable. Cable blowing also requires that the is air-tight.

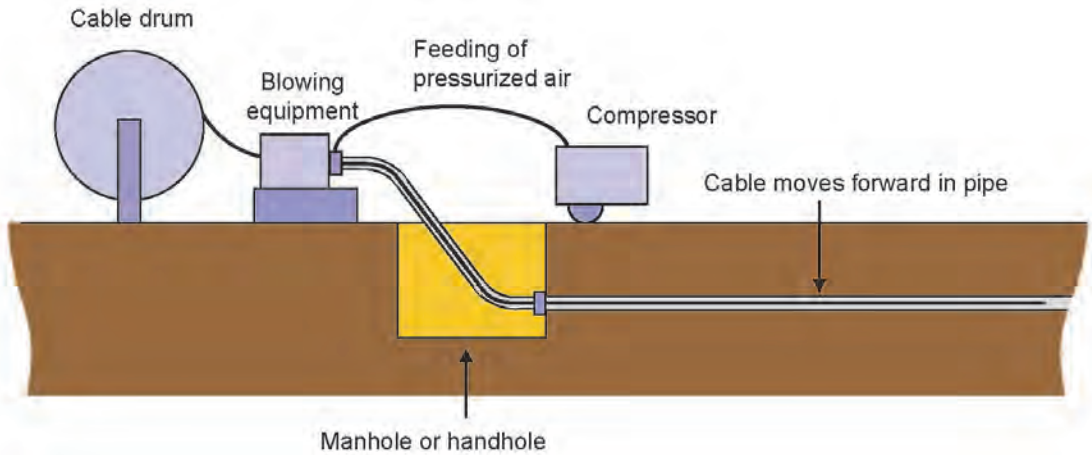

Figure 7.4. Principle of cable blowing technique.

Blowing technique has many advantages. No pulling equipment and no pulling rope is needed and the pulling force or actually pushing force is distributed evenly along the whole cable length. This technique can be applied to installation of cables with different diameters into pipes with different diameters. One more advantage of the blowing technique is also the fact that the cable can be blown into an existing pipe during any season. Examples of cable blowing are shown in figure 7.5.

Typical characteristics of a blowing system are the following:

- Diameter of the cable to blown: 6...20 mm
- Diameter of pipe to which the cable is to be blown: 20...60 mm
- Maximum blowing distance of one equipment: 3 km
- Maximum installation speed: 80 m/min
- Maximum air pressure to be fed: 14 bar

The blowing distance of even 12 km may be achieved, if intermediate blowing equipment is used within the installation route.



Figure 7.5. Cable blowing.

### 7.2.3 Air blowing of microcables into microducts

A microduct is a small, flexible lightweight tube with an outer diameter typically less than 16 mm. The microducts are able to resist pressure differences needed for installation by blowing and their inner surface has a low coefficient of friction. Microduct systems are built with protection with one or several microducts. Microducts are normally surrounded by a protective sheath and/or protected by a duct.

Microduct optical fibre cables or fibre units can be later blown into them. There are a lot of complete microduct systems on the market. If microducts are installed to each potential customer within an area, all future subscribers can have a fibre connection whenever required.

A microduct optical fibre cable is installed into the microduct by using air blowing method. A microduct cable is normally designed with a sheath, a strength member and is possibly jelly filled. It can be treated in many ways as a normal cable, but has an advantage by being both thin and elastic. The construction of this cable is very light, because it will be well protected within the microduct system.

Figure 7.6 shows examples of microducts and microduct cables.



Figure 7.6. Microducts and microduct cables.

### 7.2.4 Direct burial installation

In direct burial installation the cable is laid in the cable trench or is ploughed directly in the ground. The bottom of the cable trench shall be smooth and even. A layer of sand may be used to meet this requirement. During filling the trench care shall be taken that there are not too big stones

which may damage the cable. In order to reduce the damage caused by digging machines it is recommended to install a warning tape above the cable in the ground.

In direct burial installation the fibre optic cable is placed in the depth of 0,5... 1 m depending on the soil conditions, ground surface usage and frost conditions. Deep installations (up to 1 m) may be required in a farmer's field or at road crossing. In cold climates the cable is buried below the frost level. Detailed specifications are presented in the standard EN 50174-3.

The minimum installation depths specified in standard EN 50174-3 are shown in table 7.2. According to this standard the minimum planned depths of pathways shall be in accordance with these requirements:

- unless otherwise specified by national or local regulations
- unless additional measures are to be applied to protect the cable(s)

The depths of table 7.2 are additional to the diameters of the cable(s) such that the top of the installed cable(s) shall meet the requirements. The depth of dig may be significantly greater than that shown in table 7.2 in order to allow any protective layers to be installed below the cables.

Pathways that do not meet the requirements of planned depths of table 7.2 without effective mitigation are considered to be sacrificial.

**Table 7.2.** EN 50173-4 requirements and recommendation for pathway depths below finished surface.

Location of pathway <sup>1</sup>	Requirement	Recommendation
Footpath	0,5 m	0,5 m
Road - including parking areas	0,6 m	0,6 m
Motorway	1,0 m <sup>2</sup>	1,0 m <sup>2</sup>
Railway	1,0 m <sup>2</sup>	1,0 m <sup>2</sup>
Agricultural land	0,9 m	0,9 m
Uncultivated or landscaped land	0,5 m	0,9 m

<sup>1</sup>Increased depths may be required in accordance with agreements between the planner and the owners/operators of the land.  
<sup>2</sup>The depth of dig may be significantly greater than that shown in the table in order to allow any protective layers to be installed below the conduits.

Figure 7.7 shows examples of protection methods and installation depths of direct burial cables.

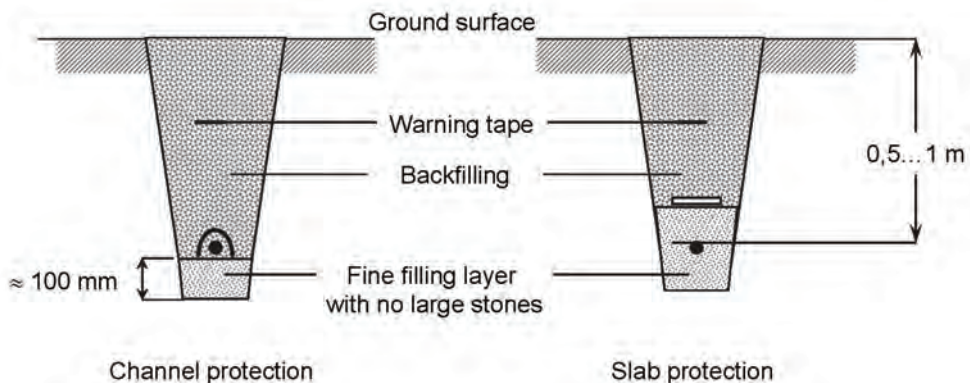

Figure 7.7. Examples of protection methods of direct burial cables.



Examples of installation are shown in figure 7.8.



Figure 7.8. Installation of direct burial cables.

Ploughing is the most rapid and economical way to install a direct buried cable where the soil is suitable for this and therefore ploughing has become a very popular installation method of direct burial cables. During ploughing it is important that proceeding is even and that the cable is not subject to excessive mechanical stresses. In ploughing it is possible to install the cable into a split protective plastic pipe and to install the warning tape at the same time. The principle of ploughing technique is shown in figure 7.9 and figure 7.10 shows photos of optical fibre cable ploughing.

In the requirements of installation depths are the same in ploughing as in laying the cable in the trench. The cable construction should be such that can stand the stresses during the ploughing. Crush and tensile strength are the most important properties for cables to be ploughed.

During ploughing it is also possible to use GPS equipment for quite an accurate positioning the cable. The position data shall be saved and documented. By using a special field mountable GPS base station (figure 7.11) and an antenna fixed to the plough the accuracy of few centimetres is possible.

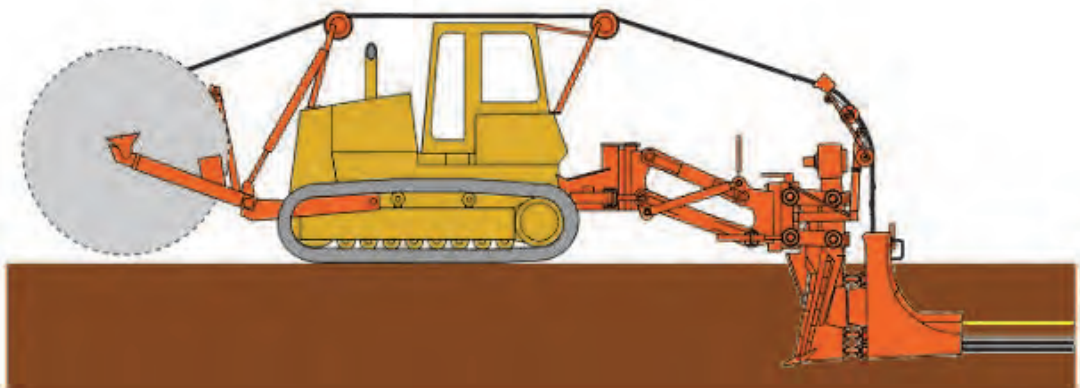

Figure 7.9. Principle of cable ploughing. (Image: Lancier Cable GmbH).



*Figure 7.10. Examples of cable ploughing.*



*Figure 7.11. Example of a GPS base station.*

When the constructions of fibre optic cables have developed the clear difference between duct cable and direct burial cable has been obscured. Constructions have been developed which are economical and can be used both for duct and direct burial installation. The use of round wire armouring in direct burial installations has been reduced. A sufficient strength can often be achieved by appropriate cable core, strength member and sheath constructions.

In direct burial installation the joint closures generally are located in ground (direct buried), handholes or cabinets. These alternatives are shown in figure 7.12. Jointing technologies are discussed more in details in clause 8.2.



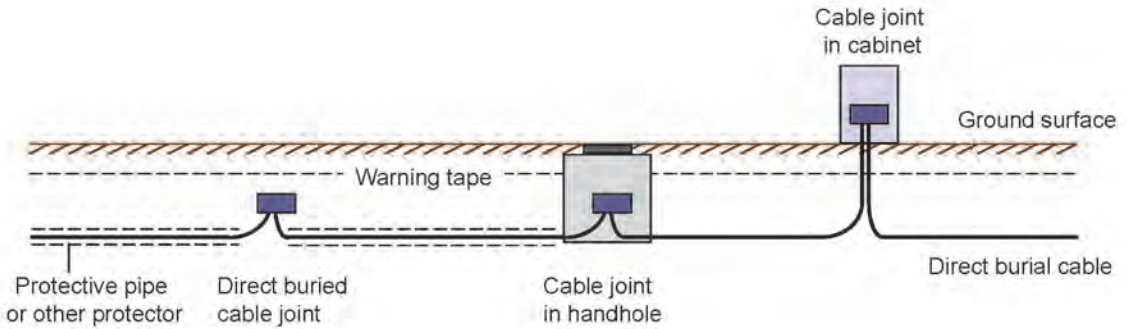

Figure 7.12. The possible locations of cable joints in direct burial installation.

### 7.2.5 Microtrenching

Microtrenching is a relatively new installation method, which has been developed especially for installations in footpaths and other light traffic paths, which are covered by asphalt. In this method special machine with a rotating blade is used to cut a low and narrow trench, where a cable, microduct or microduct bundle is then installed. The depth of the trench is typically 30...40 cm and the width is 2...5 cm. When the cable, microduct, or microduct bundle has been installed the trench is filled and finally covered by asphalt. If microducts are used the cables can be blown into microducts whenever as described in 7.2.3.

This installation method is promising and cost-effective, but it includes risks if the filling and covering are not made properly. These risks are related to water and freezing ground and their influence on the installed cables.



Figure 7.13. Microtrenching.

### 7.2.6 Aerial installation

Aerial cables are cables with integrated suspension wire of steel (figure 8) or all dielectric self-supporting cables. Aerial installation is the most economical way of installation when existing pole lines can be used.

In figure 8 cables the suspension wire is within the cable sheath and it is separated from the cable core with a narrow neck. The strength of the suspension wire designed to carry also the wind and ice load. Typical suspension wire is a stranded steel wire with dimensions of 7 x 1,20 mm, 7 x 1,57 mm or 7 x 2,12 mm depending on the required span. In Finland the stranding direction the suspension wire is right handed (Z-direction) and the specified ice load is 2,5 kg/m.

The best hanger for an aerial cable is such that allows both longitudinal and transverse movement of the cable. In windy areas it is recommended to separate the messenger from the cable by cutting the neck within a short length (figure 7.14). It is also recommended to twist the cable some turns axially within each span in order to prevent swinging of the cable.

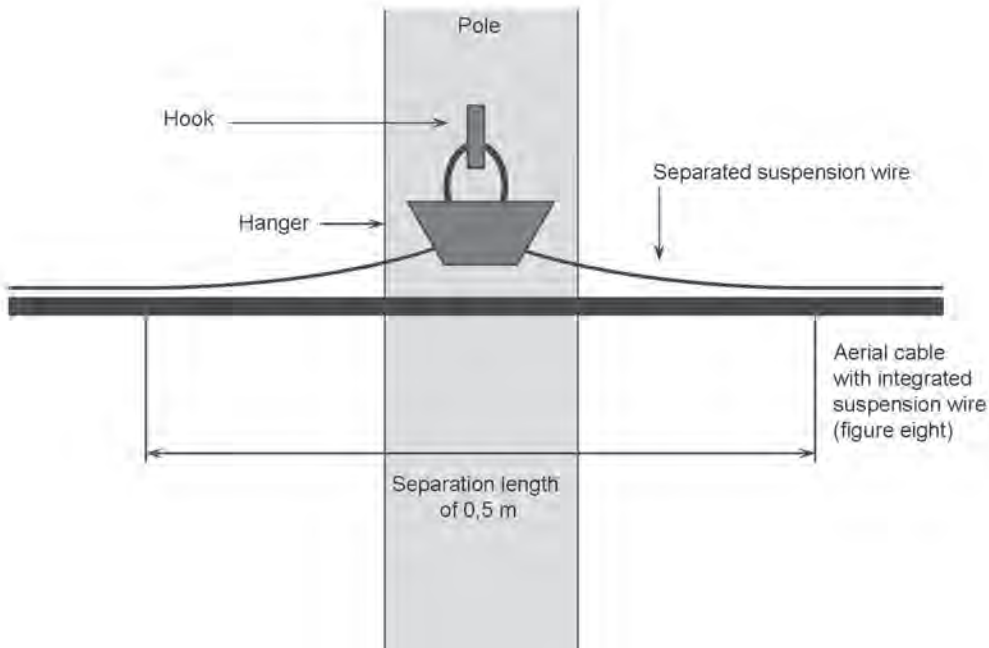

Figure 7.14. Separating the messenger from the cable at the hanger.

All dielectric self-supporting aerial (ADSS) cables are installed with special hangers designed for these cables. An example of ADSS installation is shown in figure 7.15.



Figure 7.15. Installation of all dielectric self-supporting (ADSS) aerial cable.

The cable is unreeled from the drum beside the poles to the road side. The drum is generally located in a truck or a trolley. The cable is lifted to the poles starting from the end of the line and is then tightened and fixed to hangers by using the specified sags. The sag during operation (including any maintenance activities) of the information technology cable between supporting

structures shall be determined based upon the information provided by the supplier of the cable (or catenary wire, if present) that is relevant to the following conditions:

- the distance between supporting structures;
- the predicted supplementary loadings of wind, ice and maintenance activity;
- the predicted temperature range.

The minimum height of cables shall comply with national or local regulations during installation, maintenance and operation. The clearances specified in EN 50174-3 are shown in table 7.3.

**Table 7.3.** EN 50174-3 requirements of minimum installed clearances above ground for aerial cables.

Location	Clearance m
Motorway, main roads	6
Non electric railway	6
Minor road crossings, areas accessible to vehicular traffic, field path, campus entrance	5,5
Minimum clearance no traffic crossing	4
Non-navigable waterways	5

The sags specified in Finland are shown in table 7.4. The sags of table 7.3 are based on the sag of 60 cm with the span of 50 m at temperature 0 °C.

**Table 7.4.** Sags of aerial cables with different spans and at different temperatures (Finland).

Temperature °C	Span/m								
	40	45	50	55	60	70	80	90	100
	Sag / cm								
-40	26	34	43	53	65	93	127	166	211
-20	32	41	51	63	76	105	141	181	226
-10	35	44	55	68	81	112	147	188	234
0	38	49	60	73	87	118	154	195	241
+10	42	53	65	78	92	124	161	202	248
+20	46	58	70	83	98	130	167	209	256
+30	51	62	75	88	103	136	174	216	263
+40	55	67	80	94	109	142	180	223	270
	Maximum sag with 2,5 kg/m ice load, cm								
	130	150	170	200	220	280	340	400	470

The force needed to tighten the cable can be calculated with the following formula:

$$F = \frac{G \cdot L^2}{8 \cdot f} ,$$

where  $F$  is the force needed to tighten the aerial cable, N

$G$  is the weight of the cable, N/m

$L$  is the span length, m

$f$  is the sag, m

In aerial installation the joint closures generally are located on poles as shown in figure 7.16. The metallic suspension wire is spliced with sleeves designed for that purpose. The suspension wire splice shall have the same tensile strength as the wire itself.

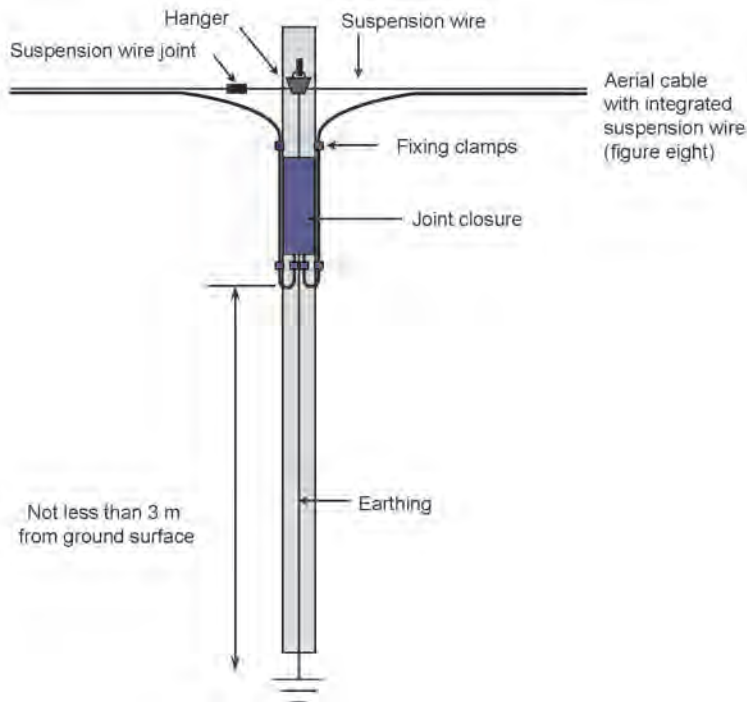

Figure 7.16. Principle of jointing the aerial cable.

### 7.2.7 Underwater installation

Underwater cables are subject to great crush and tensile stresses. Therefore they are generally provided with round wire armouring. Small cables are laid by using a ferry or boat. At lakesides and banks cables are protected and fastened. The basic principle of underwater installation in shallow water conditions is shown in figure 7.17.

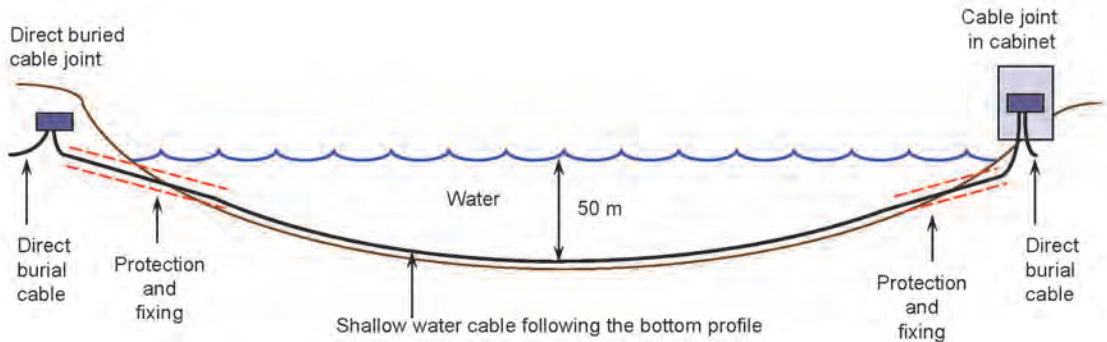

Figure 7.17. Shallow water installation.

Appropriate markings shall be used on the banks of the waterway. The markings shall be in accordance with the local requirements.

### 7.2.8 Indoor installation

Indoor cables are installed into the pathways of the building. These pathways are typically cable trays, cable ladders, conduits and trunking systems. Also blown fibre technology can be used.

Cable lengths more than 50 m are generally delivered on drums. During installation of connectorized cables care should be taken to not damage the connectors. Pulling from connectors is not allowed.

The installation requirements of standard EN 50174-2 shall be met.

### 7.3 Lightning protection

In direct burial and aerial installation also lightning protection shall be taken into account. In areas where thunderstorms are frequent, lightning protection needs a special attenuation.

Although the signal transmitted in an optical fibre cable is transmitted in a dielectric waveguide, the cable often contains metallic and conductive elements. Such elements in the cable may be the metallic sheath and metallic strength members as well as the metallic suspension wire of the aerial cable.

When optical fibre cables with metallic elements are used in the optical access network the relevant national or local requirements and regulations shall be followed. Requirements are also specified in the standards EN 50174-3 and standard series IEC 62305 as well as in K-series recommendations of ITU-T.

The following principles and practices are recommended:

- The metallic elements of the cable shall be connected to the earthing system at telecommunications stations, in cabinets containing active equipment and in other cabinets, which are installed on the ground or are at arm's reach from the ground.
- The metallic elements of cables shall be connected to each other at the cable joint closures and joint cabinets.
- The suspension wires of aerial cables shall be connected to each other at the aerial cable joint.
- The suspension wire of the aerial cable shall be connected to earth at the points, where the metallic sheath is earthed and at the end of the aerial cable section.
- The metallic elements of the drop cables shall be earthed at the ends of the cable branches.

An all dielectric cable construction gives the best protection, but with cables containing metallic elements the risks of the lightning can also be reduced significantly with proper earthing of metallic elements.



Localization of a cable in the field has been traditionally carried out with an electric current fed into metallic parts of the cable and the magnetic field induced by the current. Non-metallic cables can be localized by using a separate copper conductor installed parallel to the direct buried cable or by using inductive markers with appropriate intervals. GPS technology can also be utilized provided that the position data from GPS is saved and documented during the installation.

#### **7.4 Considering other use of installation environment and bringing the cable to site**

In constructing the optical access network and installing cable also other use of the installation environment shall be considered. The construction of optical access network shall not cause any risks or adverse effects to other technical systems installed and built in the environment and these systems shall not cause risks or adverse effects to the optical access network. Essential items in this sense are the following:

- Installation depths of duct and direct burial cables and distances from other structures
- Protective structures used with duct and direct burial cables
- Requirements of poles in aerial cable installations
- Sags, spans and installation heights of aerial cables
- Location maps and marking

These and more items are discussed and specified in the standard EN 50174-3.

Municipalities, electric power companies and teleoperators generally gives information of their building plans to other parties which may be interested in coming with to the digging project. The owner of the optical access network should also inform all other parties of its plans, because these may be interested in co-operation.

It is also recommended that the municipalities while building their pipe networks (water, sewer, remote heat) also would install at least one 40 mm diameter pipe, which could be hired or sold to cable installation purposes when needed.

If it is not possible to install the optical fibre cable up to the building distributor at one time, the cable should be left coiled at the border of the site or at the side of the building. This should be agreed with the owner of the building. If the cable is left coiled at the border of the site, the cable length should be sufficient to reach the building distributor.

In the case of a new building it is recommended that installation and digging is scheduled to be made at the same time with digging needed for public utility services.

The optical fibre cable shall be installed unbroken and continuous to the building distributor and with at least 3 m of extra length for termination purposes. The pipe under the footing shall have a diameter of at least 50 mm and bending radius of not less than 200 mm. It is recommended that this pipe extends to the border of the site and thus gives protection to the cable. A pulling rope should be installed within the pipe to enable the easy installation of the cable.

## 8 Splicing, jointing and termination of optical fibre cable

### 8.1 Splicing of optical fibres

Optical fibres can be spliced with two main methods, which are the following:

- Fusion splicing
- Mechanical splicing

#### 8.1.1 Fusion splicing

Fusion splicing is the most secure and reliable way to make a good quality fibre splice.

In fusion splicing the fibre ends are aligned to each other and fused together with an electric arc. Alignment and fusion is carried out by an automatic fusion splicer. The following stages of operation are included in making a fusion splice:

- Stripping of fibre coating
- Cleaning of fibre
- Cleaving of fibre
- Fibre positioning fusion splicer
- Alignment and fusion with electric arc
- Inspection of splice (attenuation and tensile strength)
- Protection of splice

Stripping of fibre means removing of the primary coating at the required length which is typically 3 cm. Stripping is made by using a special stripping tool or stripper. The stripper cuts and removes the primary coating without damaging the fibre. It is very important to use a proper stripping tool in order to avoid damaging the fibre. Even a small scratch degrades the fibre strength and makes it subject to fatigue phenomenon.



a) Fibre stripper



b) Fibre cleaver

Figure 8.1. Fibre stripper and fibre cleaver.

After stripping the bare fibre end is cleaned carefully with alcohol and cleaved. The target of cleaving is to produce a clean, even and flat cut surface for splicing. The cut surface shall be perpendicular to the fibre axis with an angular error less than one degree. The cleaving is based on the same principle as the function of a conventional glass cutter. The fibre is first subject to a small tension and gentle bending and then the fibre is touched with a diamond point. This makes the fibre cleave smoothly at the point of the scratch. All this is made by using a special cleaver.

The length of the cleaved and stripped fibre is 8...16 mm.

Fusion splicing is made with a special fusion splicer. Stripped, cleaned and cleaved fibre ends are positioned into the fusion splicer, which generally does the functions of alignment and arc fusion automatically. In cheaper fusion splicers some functions may also be manual. The fibres are aligned either on the basis of the fibre core by using a small TV camera and a processor (PAS-method) or on the basis of the fibre cladding. Alignment on the core basis (PAS-method) gives a better performance, but alignment on the cladding basis has also become common as the fibre geometry tolerances have been improved. The modern fusion splicer also gives an estimation of the splice loss and tests the tensile strength of the splice. The splice loss estimation is based on the calculations made by the splicer processor. In practice an average splice loss of less than 0,1 dB can be achieved for both singlemode and multimode fibres. Figure 8.2 shows an example of a fusion splicer and figure 8.3 shows splicing of optical fibres with fusion splicers in the field.



Figure 8.2. Fusion splicer.



Figure 8.3. Splicing of optical fibres with a fusion splicer.

Fibre ribbons (2...16 fibres) are spliced with a mass fibre fusion splicer. The stripping, cleaning and cleaving operations before mass fibre splicing are carried out on the same principles as for a single fibre. Special tools for fibre ribbons are available for these operations. The mass fibre fusion splicer can also be used for single fibre splicing or for splicing fibre bundles. For splicing fibre bundles the single fibres are arranged to form a ribbon for splicing. This is made with a special fibre holder and adhesive or tape.

The last stage of operation in fusion splicing is to protect the fibre splice with a splice protection sleeve. This is typically a heat shrinkable sleeve reinforced with a steel pin. The fibre has been drawn through the sleeve before splicing. The typical length of the splice protection sleeve is 40 or 60 mm. Heat shrinking is carried out by the oven which usually is an integral part of the splicer.

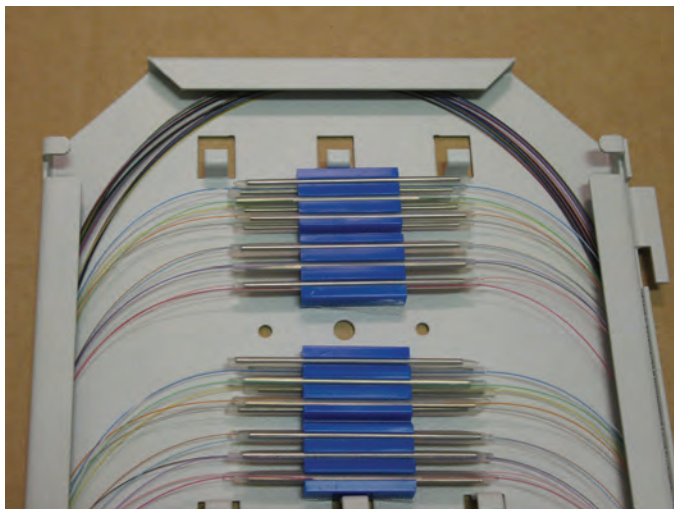

Figure 8.4. Splice protection sleeves on the splice tray.

### 8.1.2 Mechanical splices

In a mechanical splice the fibre ends are aligned to each other by using a V-groove or metal pins in a sleeve. Fibres are locked by using adhesive or crimping. Refractive index matching gel is often used in the mechanical splice to improve the optical characteristics of the splice. A typical splice loss to be achieved with a mechanical splice is 0,2 dB, but also splice losses of as low as 0,1 dB have been achieved.

Mechanical splices are quite popular e.g. in USA. In Europe mechanical splices are not as common as permanent splices.

Cost efficiency has often been mentioned as the advantage of a mechanical splice, because no fusion splicer is needed. Mechanical splicing, however, requires its own tool and accessory set and these are different with different suppliers. On the other hand the price development of fusion splicers has been very favourable during the last decade and there are really cost effective fusion splicers in the market, especially for LAN and access network applications. In most cases during a longer time the costs of mechanical splicing grow higher than the costs of fusion splicing. It should also be noticed that a secure and reliable mechanical splice requires much more exercise, care and skill from the installation staff and includes more uncertainties than a fusion splice. In some situations, however, using mechanical splicing is well justified. Temporary splices, splices for measurement and testing and repair splices, when the fusion splicer is not available at the moment, are examples of these situations. Mechanical splices should not be used in permanent fibre splices of the outside plant. Figure 8.5 shows an example of a mechanical splice.



Figure 8.5. Example of a mechanical splice.

## 8.2 Jointing solutions

### 8.2.1 Jointing solutions in the outside plant

When choosing the joint solution, the following aspects should be considered:

- Joint closure or joint cabinet
- Joint location: in manhole or handhole, in cabinet, on pole , in ground
- Suitability for the cable constructions to be used
- Number of cable entries required
- Fibre capacity
- Fibre management
- Physical size: suitability for manholes
- Installation and assembling characteristics
- Suitability for mid span access
- Re-entry characteristics
- Total costs

In outside plant there are two main alternatives to be chosen for a jointing solution. These are:

- Using of closures in manholes, handholes, in ground or on poles (figure 8.6)
- Using of outdoor cabinets containing fibre splices or cross-connections (figure 8.7)

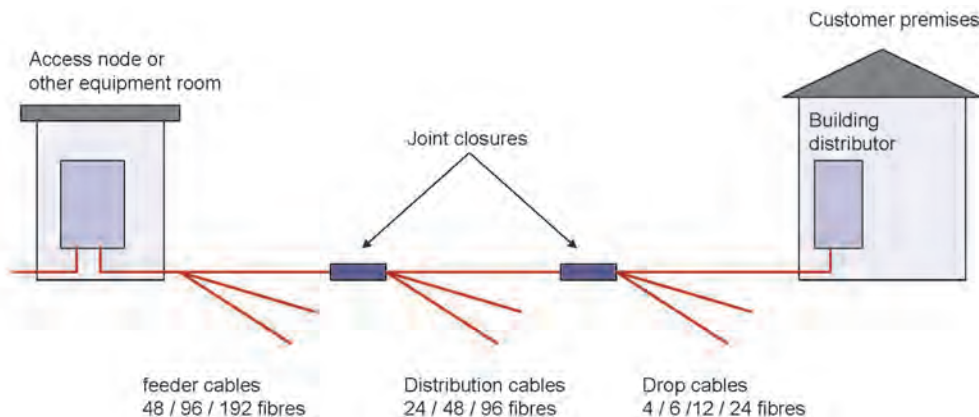

Figure 8.6. Use of joint closures in the access network.



Joint closures are most suitable for direct cable joints. Direct joints are used for increasing the length of the cable route in outside plant or for jointing an outdoor cable to an indoor cable at the building entrance point. The location of a joint closure may be chosen quite freely wherever needed: in manhole, in ground, in cabinet or on pole. Joint closures can be used also for branching joints, but the number of branching cables is limited by the number of cable entries of the closure.

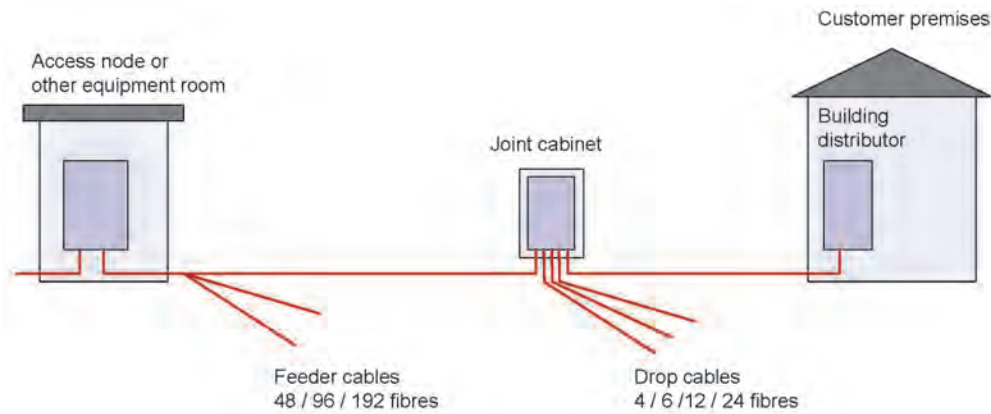

Figure 8.7. Use of joint cabinets in the access network.

Joint cabinets are passive optical distributors with fibre splices or cross connections. They are most suitable for locations where the feeder cable or distribution cable is branched to several small size drop cables in different directions. The construction of a joint cabinet consists of two cabinets and the fibre splices or cross connections are located inside the inner cabinet. All moisture will be condensated in the space between the cabinets and the space inside the inner cabinet is always free of moisture.

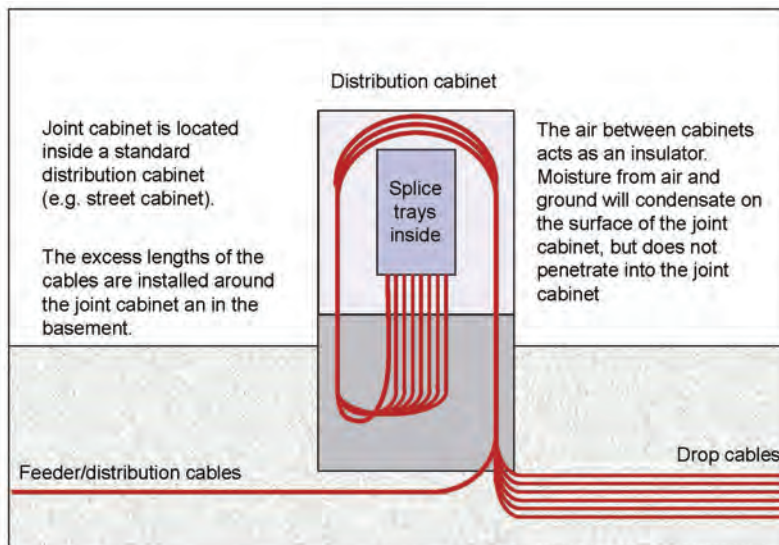

Figure 8.8. Principle of joint cabinet.

The number of cable entries can be much greater than with joint closures and this is a great advantage of the joint cabinet. The construction and the great number of cable entries makes it easy to expand, reconfigure and maintain the network.

Joint cabinets are always installed on the surface and they are some kind of visual landmarks.

Therefore they cannot be located freely, but have some restrictions regarding the location. They may also be subject to risks of traffic and vandalism.

### 8.2.2 Mid span access

Mid span access is a method, which enables branching of an installed optical fibre cable without a need to cut the whole cable. Mid span access can be used for branching of feeder or distribution cables whenever there is a need for this and just on time. During the initial installation only one feeder cable with high number is installed and loops with sufficient excess length of cable are located in possible branching points, which may be manholes or cabinets.

Figure 8.9 shows the principle of the mid span access splicing and figures 8.10 and 8.11 illustrate the application of the mid span access method in rural area and in urban area.

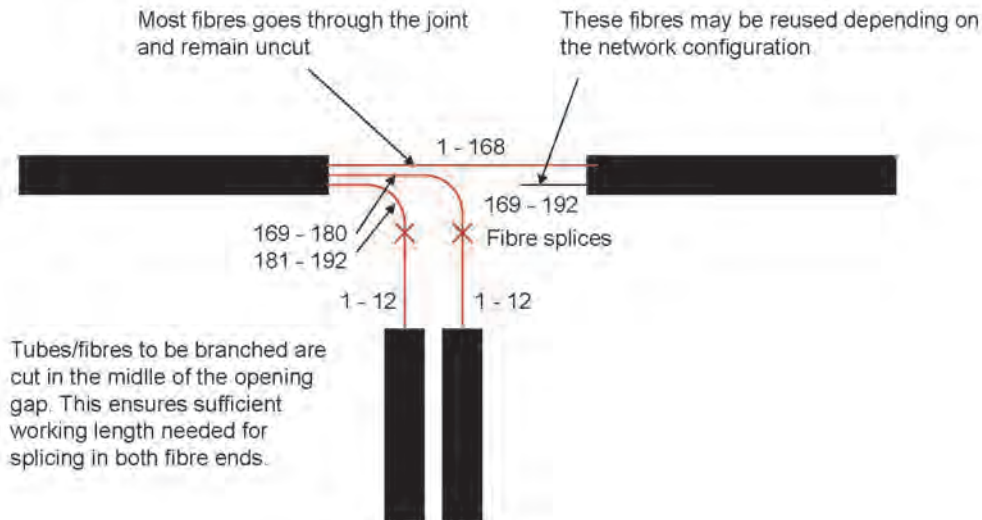

Figure 8.9. Principle of the mid span access splicing.

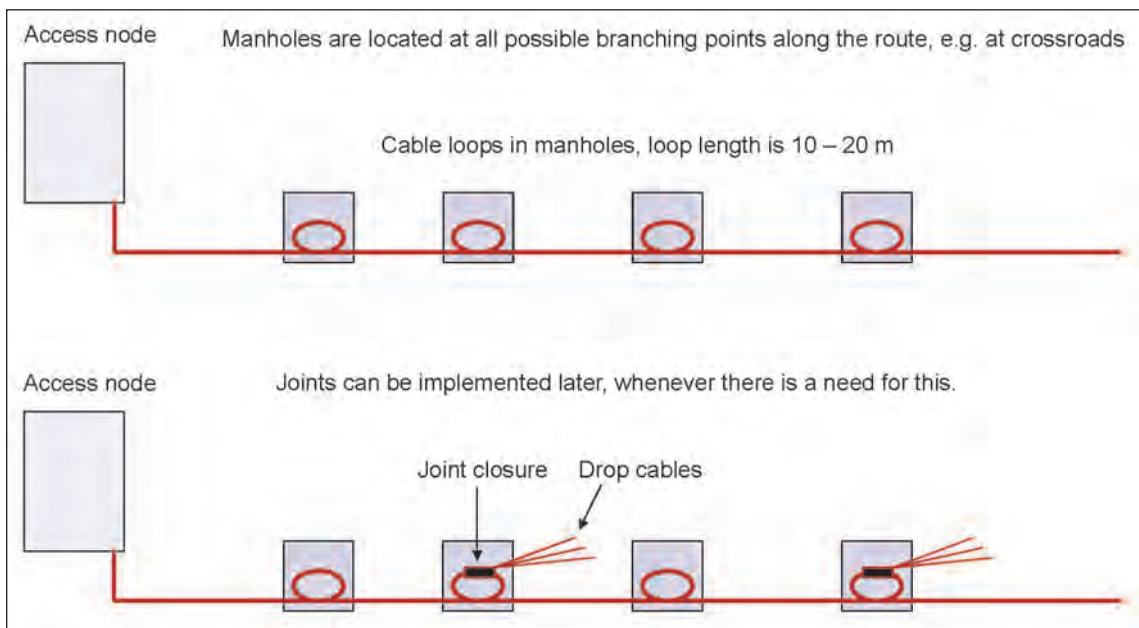

Figure 8.10. Application of the mid span access splicing in rural area.

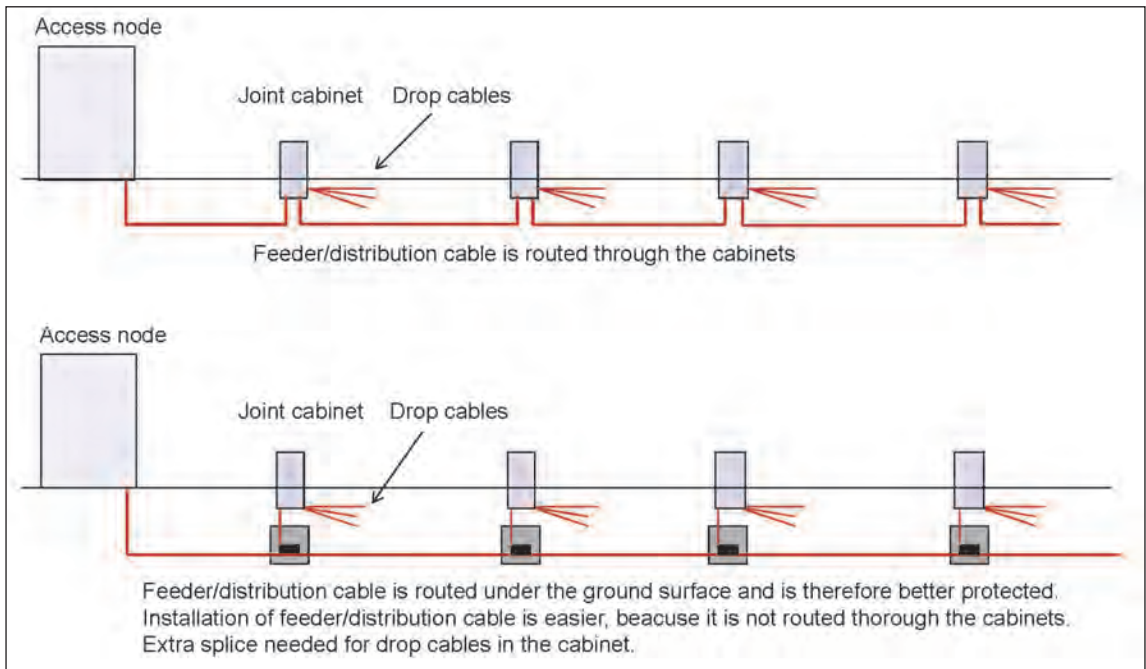

Figure 8.11. Application of the mid span access splicing in urban area.

It shall be noted that although in principle the mid span access is possible with all cable constructions in practice it requires the stranded loose tube construction. Especially cables with flexible tubes are optimal for mid span access. Mid span access with central tube construction may be very difficult or even impossible in practice.

Saving in splicing costs is the main advantage of the mid span access splicing. But the saving will be achieved only with high fibre count cables, typically with cable with at least 48 fibres. The joint closure used for the mid span access splicing should be provided with sufficiently wide cable entry. This is an important aspect when choosing a joint closure for mid span access splicing. Of course a joint cabinet may also be used with mid span access splicing.

### 8.3 Termination of optical fibres

The optical fibre shall be terminated to an optical fibre connector for connecting the fibre to a patch panel, connector field or equipment. There are alternative ways for terminating of fibres. The three basic alternatives are the following:

- Splicing to fibre pigtails. The fibres of the cable to be terminated are spliced to factory made fibre pigtails.
- Using of factory made connectorized cables (cable assemblies) . Termination points are connected with factory made cables with customer specified length and connector types at both ends.
- Field mounting of connectors. The connector is mounted in the fibre end in the field conditions during the installation.

#### 8.3.1 Using of fibre pigtails

The fibres of the cable to be terminated are spliced to factory made fibre pigtails. Generally fibre pigtails have a length of 1,5 or 2 m and fibres have tight secondary coating (900 µm). Fibre pigtails are more discussed in clause 4.1.3 of this book. Splicing can be made either by fusion splicing or by mechanical splicing. Fusion splicing is recommended, because it results in better reliability and optical performance. Mechanical splicing requires more exercise and it includes

more uncertainties than fusion splicing.

The connectors of fibre pigtails are mounted in the factory by the specialized and skilled personnel in well controlled conditions and are polished with sophisticated methods. After assembly the pigtails are tested in order to assure the quality and performance. A responsible manufacturer of pigtail takes care of the quality and guarantees a specified performance.

### 8.3.2 Using of connectorized cables

In addition to pigtails also connectorized cables or cable assemblies are available. These cables may have 48 or even more fibres. These kinds of connectorized cables can be used when the outdoor cable is being terminated. The outdoor cable is spliced at the building entrance to connectorized (and fire safe) indoor cable. The customer can specify the length of the cable, type and number of fibres, and the connector type. No fusion splice is needed if the cable has connectors at both ends. Figure 4.8 shows examples of connectorized cables.

### 8.3.3 Field mounting of connectors

Field mounting of connectors has increased its popularity during recent years. It has become a remarkable alternative to using of pigtails especially in multimode installations. There are several alternative filed mounting methods and products in the market.

Most popular field mountable connector type is such that has a short length of fibre inside the connector body and a factory polished ferrule. The fibre to be terminated is inserted into the connector and spliced with a specific tool mechanically with the short fibre inside the connector body. Index matching gel is often used within these connectors to improve the optical characteristics of the fibre splice inside the connector.

There are also field mountable connector types which require field polishing. In fact, however, the quality of polishing is difficult and often even impossible to be controlled in field conditions.

There are both good and bad experiences of the field mounting of connectors. As a summary it can be stated, that many critical factors and uncertainties are connected with field mounting methods. With good products and with good skill and workmanship it is, however, possible to achieve sufficient quality for some indoor applications. In the outside plant singlemode installations field mounting of optical fibre connectors is not recommended at all. The economic benefits to be achieved in turn depend on the quantities to be terminated.

## 8.4 Quality of fibre connections

Splicing and connecting fibres are always critical for performance and reliability. The final result of fibre splice or connection is influenced by many factors. These factors should be recognized and considered when components and installation methods are chosen. Typical and most important critical factors of fibre splices and connections are listed in the following:

- Fibre types to be spliced or connected. The fibres to be spliced or connected should be of the same type (core/cladding dimensions, mode field diameters). In other cases an extra loss will be resulted. This extra loss depends on the ratio of diameters of fibre cores and mode field diameters. See also the next bullet.
- Mode field diameter (MFD). Splice loss and connection loss (insertion loss) depend on the MFD difference of the fibres to be spliced or connected. Standards allow MFD range of 8,0...10,1  $\mu\text{m}$  for singlemode fibres (G.652.D). If the MFDs of fibres to be spliced or connected are at the opposite limits of this range, the splice/connection loss due to MFD difference is 0,24 dB. Splice /connection loss of 0,1 dB allows MFD ratio (MFD1/MFD2) not more than 1,145. The recommendation for MFD range for singlemode fibres is  $9,2 \pm 0,4 \mu\text{m}$ .
- Alignment of fibres. Angular error, axial error or radial error results in an extra loss. Modern fusion splicers generally observe automatically at least rough. If mechanical splices are used, these errors may be unobserved and in this case they cause extra loss.



- Quality of polishing. The polishing of the fibre end and ferrule end shall be in accordance with the specified requirements (see clause 4.1). Radius of curvature, convex vertex eccentricity and fibre withdrawal all affect both insertion loss and return loss. The fibre end and ferrule end shall also be clean and free of scratches and other defects.
- Cleanliness of connector. This is an essential factor in all optical fibre connections. It is vitally important to clean all connectors and adaptors each time before connecting. Any dirt in connectors and adaptors degrades significantly the performance and no reliable result of the real performance of the cabling can be obtained. In the worst case the data traffic may be totally interrupted. Cleaning cassettes or cotton swabs can be used for cleaning. Cleanliness can be ensured only by using a microscope designed for this purpose or a video microscope. The ends of optical fibre connectors shall be protected with dust caps, always when not in use. Figure 8.12 shows examples of connector ends with different qualities.

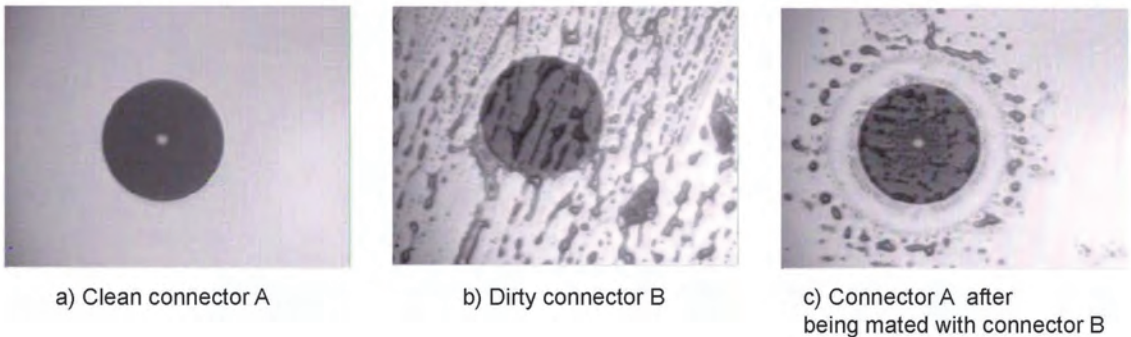

*Figure 8.12. Photos of video microscope showing the ferrule end quality.*

- High power transmission. Optical signal at 100 mW to 1 W signal power is mainly used for WDM (Wavelength Division Multiplexing) systems. When optical power of this magnitude is transmitted within a singlemode fibre any contamination on the end face of a fibre optic connector will be heated to extremely high temperatures. This results in possible vaporization of the contaminate and melting of the glass, thereby destroying the integrity of the connection and requiring a complete replacement of the connectors.
- Meaning of return loss. The optical power reflected back at the connector interface causes interferences to the signal transmission. This optical power may be reflected once again in forward direction at some other connector interface and appear as a ghost signal in the receiver. Signal transmission may also be degraded by the noise generated in the laser source due to the optical power reflected back from the link and returning to the laser source.

## 8.5 Distributor installations

Distributors are structures where the cables are terminated and connected to the other cables or equipment. Patch panels and other connector fields are generally installed into racks and cabinets. There are also active telecommunications equipment in distributors. The number of cables coming to and leaving from a distributor may vary from a few cables to hundreds of cables depending on the type of the distributor. It is very important that the distributor including all cable installations has been designed, planned and installed with appropriate skill and knowledge.

Especially the following items shall be considered in the distributor installations:

- Choosing and locating racks and cabinets in the distributor room.
  - The functional aspects should be taken into account in choosing the rack or cabinet. It is recommended to locate the racks and cabinet on the floor in such a way that there is working space between the rack or cabinet and the wall. This is important especially, when the racks or cabinets include active equipment.
- Locating panels (or connector fields) and equipment in the racks and cabinets.
  - It is recommended that a dedicated and own cabinet is reserved for equipment and one or more rack(s) or cabinet(s) are reserved for the cable terminations. Only in small



distributors the equipment are recommended to be installed in the same cabinet with the cable terminations.

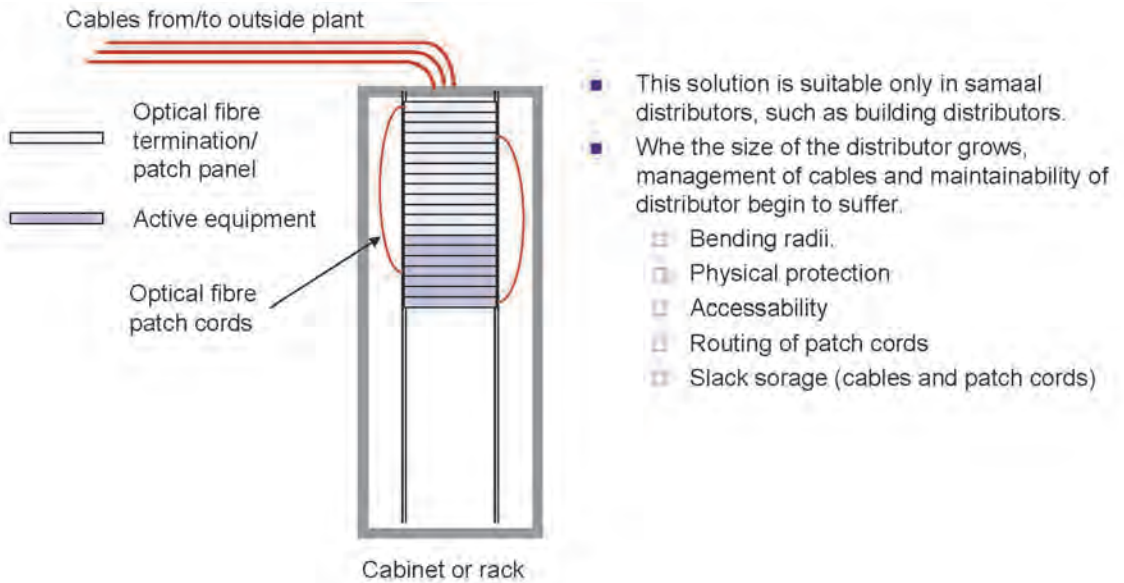

Figure 8.13. Cable terminations and active equipment in the same cabinet/rack.

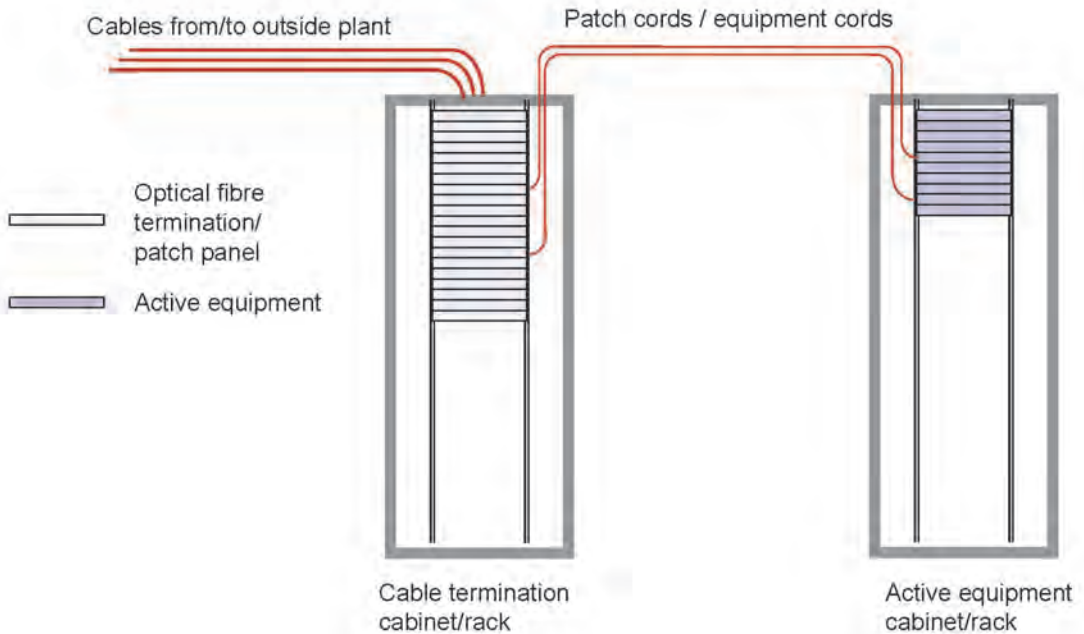

Figure 8.14. Cable terminations and active equipment in separate cabinets/racks.

- Cable entrances to the distributor room, racks and panels.
  - The cable entrance shall be planned well before installation. In order to achieve clarity and manageability the cables should be grouped in appropriate way for termination. Installation instructions of cable shall be strictly followed in each phase of the installation. For example too sharp bendings shall be avoided. Cables are fixed to the mechanical structures e.g. by using appropriate binders and without excessive pressure.

- Choosing the method of fibre termination.
  - The most recommended method is using fibre pigtails and fusion splicing or using connectorized cables (outdoor cables). In singlemode installations field mounting is not recommended in any cases.
- Management of excess fibre lengths (fibre slacks).
  - Excess fibre lengths are need for termination purposes. These excess lengths of fibres shall be managed and stored in the space reserved for this purpose. Generally the excess fibre length is coiled on the spliced tray or on the bottom of the closure.
- Management of patch cords.
  - The management of patch cords connecting the patch panels or interconnecting the patch panels with equipment is also important. Patch cords should be installed in a well-managed way and they should not hang down or form "spaghetti". Management accessories are available and recommended for management of patch cords.
- Maintenance and service aspects.
  - Active equipment, cables, fibre pigtails, fibre splices and patch cords should be located and installed in such a way that maintenance activities may be carried out with ease and with minimum disturbance to telecommunications systems operating in the distributor. For example movement of an active fibre may cause even 6 dB loss transients in a singlemode fibre.
- Cooling and air conditioning.
  - Active equipment may also require cooling and air conditioning in order to keep the temperature within the specified limits.

## 8.6 Building entrance and termination of outdoor cables

Building entrance facilities are required whenever the fibre optic cable enters the building. These facilities comprise an entrance point at a building wall and the pathway leading to the distributor (ODF) or other termination point. At this termination point, a change from outdoor cable to indoor cable can take place.

The following aspects should be considered in the building entrance of the outdoor cable:

- Installation method of outdoor cable: duct installation, direct burial installation or aerial installation.
- Location of entrance point with respect to location of distributor or other termination point.
- Earthing of possible metallic elements of the outdoor cable.
- Available cable routes and pathways in the building from entrance point to distributor or other termination point.
- Jointing of outdoor cable to indoor cable at the entrance point inside the building.
- Fire safety of indoor cable (flame/fire retardant, zero halogen, low smoke), fire safe lead throughs, etc. (see clause 8.7).

Outdoor cable can be terminated to the first distributor or other termination point in the building with the two following ways:

- Outdoor cable comes directly to the distributor (without jointing to indoor cable) and the fibres of the cable are spliced to the fibre pigtails.
- Outdoor cable is jointed with fusion splices to indoor cable (connectorized cable) at the entrance point inside the building. The connectorized end of the cable is terminated to the patch panel in the distributor (see figure 8.15).

Figure 8.15 shows an example of outdoor cable entrance arrangements. Outdoor cable has been jointed to indoor cable at the entrance point inside the building. The indoor cable is a factory connectorized cable and its connectorized end is terminated to the patch panel in the distributor. This installation is fire safe and also the problems caused by cable jelly in the distributor can be

avoided. With this practice it is also to splice the by-passing fibres at the entrance joint and these fibres are not needed to bring to the distributor and back.

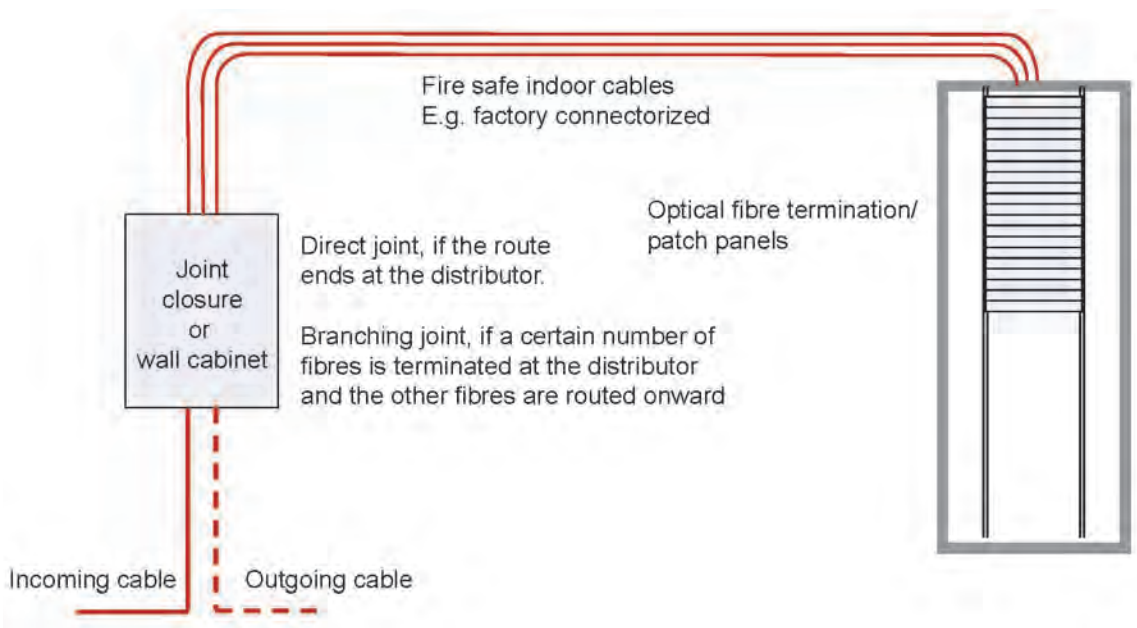

Figure 8.15. Example of outdoor cable entrance and termination arrangements.

## 8.7 Safety

### 8.7.1 Fire safety

Using cables with sufficient fire performance is extremely important (see clause 3.3.7), but also the right installation methods are important for the total fire safety of the cabling. In the installation the following aspects should be considered:

- Outdoor cables should be spliced to fire safe indoor cables at the cable entrance.
- Installations in rooms and areas with fire risks should be avoided.
- Fire barriers in wall openings and lead throughs shall have sufficient burning time and heat isolation and they shall be gas tight.
- The fire safe leads through shall enable adding of cables.
- Fire safety during installation work is also important.

### 8.7.2 Work safety aspects of fibre optic installations

In fibre optic installations also some safety aspects should be kept in mind and instructions concerning safety should be followed.

Short pieces of fibres which come from splicing and terminating shall be collected and put into a box. Care should be taken that they are not being left on table, in clothes or somewhere from where they can penetrate into the human skin.

Some solvent chemicals used in cleaning are flammable and intoxicating and may cause irritation symptoms. If there are any instructions for ventilation or use of protective equipment these shall be followed.

Laser radiation is invisible, but dangerous for an eye. It can cause damage to the retina. Unused connectors and fibre ends shall always be closed. It is never allowed to look straight towards

the fibre end or connector end. It is also recommended to use laser warning stickers in optical distribution frames and in other racks containing fibre optic equipment. Laser safety aspects are specified in the standard IEC 60825.



*Figure 8.16. Laser warning label.*

## 9 Measurements of optical fibre links

Measurement, testing and inspection of installed link are an essential part of the access network implementation. Each optical fibre link shall be tested when the cable has been installed, jointed and terminated. Measurements are needed also in maintenance activities, such as changes, extensions and fault location. The purpose of the measurement is to ensure that each installed optical fibre link meets the specified transmission requirements. The measurement reports are, however, also an important part of the documentation of the network.

The most important measurements and inspections are the following:

- Measurement of link attenuation using OTDR or light source and power meter (LSPM)
- Measurement of connection insertion loss and splice loss using OTDR
- Measurement of return loss or reflectance of connection using OTDR
- Measurement of link length and other distances using OTDR
- Continuity test of fibres using visible laser
- Inspection of cleanliness of optical fibre connector endface using video microscope

### 9.1 Measurement of attenuation with OTDR

OTDR measurement is the most important and most common measurement in installation and operation of singlemode fibre cable links of the optical network. OTDR measurement is based on the backscattering phenomenon and on the reflection of light due to changes of the refractive index in the fibre. The abbreviation OTDR comes from words Optical Time Domain Reflectometer. The principle of the OTDR is presented in figure 9.1.

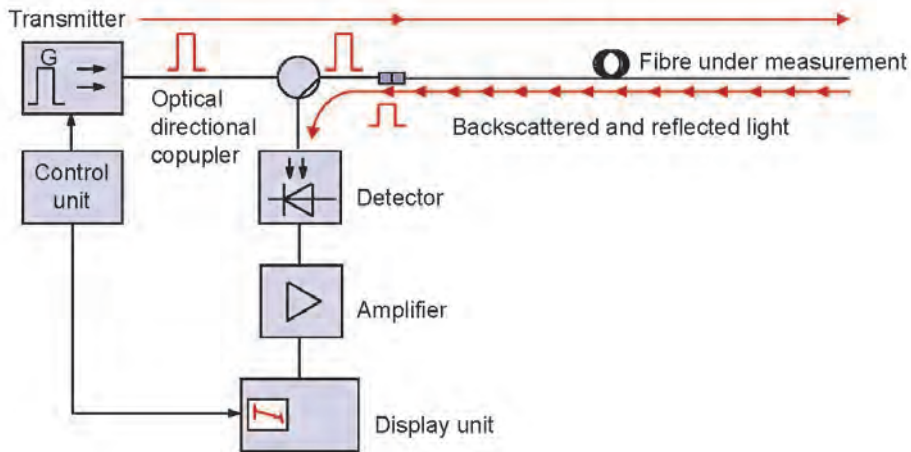

Figure 9.1. Principle of OTDR.

An optical pulse is transmitted to the fibre through a directional coupler. This pulse propagates along the fibre and is attenuated by the amount determined by the fibre attenuation. A small portion of the optical power is backscattered along the whole length of the fibre and travels towards the near end of the fibre. The backscattering phenomenon is a characteristic property of the fibre and at each point of the fibre the same amount of the optical power is backscattered. In addition, each change of the refractive index in the fibre causes a certain portion of the power to reflect in backward direction. Splices, connections and possible defects in the fibre are examples of these kinds of changes. Also the free end of the fibre represents a change of the refractive index. The backscattered and reflected optical power is coupled by the directional coupler to the detector and is amplified, processed and fed to the display unit. The OTDR display shows the backscattered



and reflected power level as the function of time. When the propagation velocity of light in the fibre is known the time scale can be converted to length scale.

The following information can be read from the OTDR display:

- Total link attenuation and the distribution of attenuation along the optical fibre link
- Splice losses and connection (insertion) losses and their location (distance)
- Total link length
- Location of possible fibre break or other fault within the optical fibre link

The measurement of attenuation with the OTDR is based on the fact that the degree of backscattering is constant along the fibre i.e. the same amount of optical power is backscattered at each point along the fibre. The display shows decreasing power level as the function of the length (time) and this decrease is just caused by the attenuation. In figure 9.2 attenuation A (dB) between points 1 and 2 is the difference between the respective power levels  $L_1$  (dBm) and  $L_2$  (dBm):

$$A = L_1 - L_2 \text{ (dB)}$$

In fact this attenuation is twice the difference between the respective power levels in points 1 and 2, because the light has travelled twice the distance between the points 1 and 2. The power level scale of the display, however, is calibrated to show the real power level and the factor 0,5 can be neglected. The measurement is made easy with the cursor which can be moved on the display.

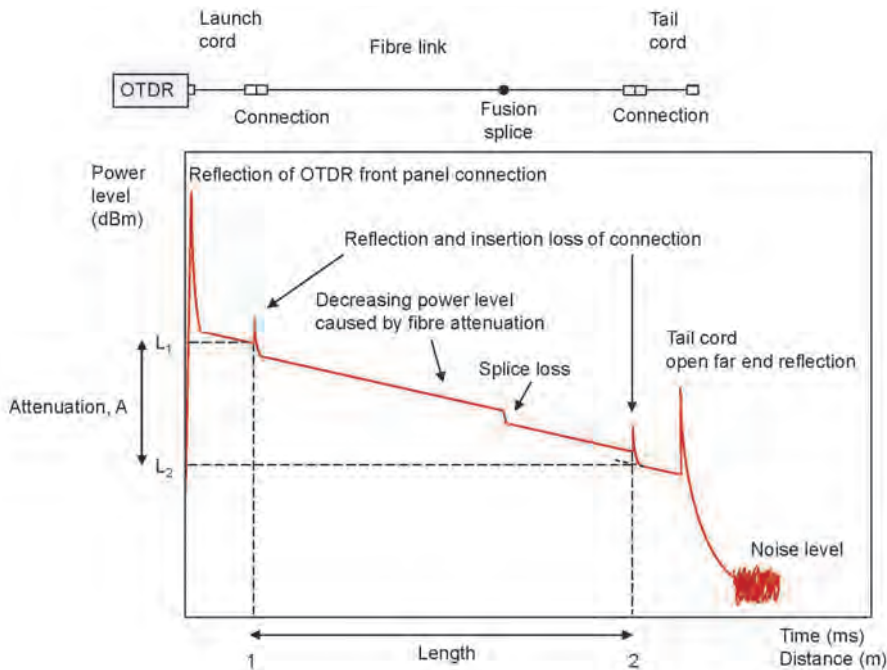

Figure 9.2. Interpretation of OTDR display.

As the example in figure 9.2 shows the OTDR display gives diverse information of the optical fibre link under measurement. The length of the fibre link can be read from time/distance-axis and it is the difference of distances at point 1 and point 2. When measuring the splice loss the measurement should be carried out from both directions in order to achieve the correct and real

value. The real splice loss is then calculated as the mean value of the two measured splice losses. Also the fibre attenuation can be measured more accurately, if the measurement is carried out from both directions and the mean value is calculated. Launch cord is used to eliminate the effect of the dead zone caused by the great front panel reflection. Use of launch and tail cords also enables to measure the connection insertion loss at the far end of the optical fibre link.

Final measurements include measuring of the total link attenuation, each splice loss, insertion loss of each connection, return loss of each connection and the length of each optical fibre link. Also the coefficient of attenuation of each fibre and possible attenuation discontinuities are generally measured. The OTDR displays are saved in a digital form on the fixed memory of OTDR or on the memory card. The measurement wavelength is generally 1550 nm. This wavelength is more sensitive e.g. for excess loss caused by bending than wavelength of 1310 nm. The one and same measurement gives all required information of the link length. The length information is based on the measurement of propagation delay, which depends on the refractive index of the fibre. Therefore the correct value of the refractive index shall be set to the OTDR.

Use of the OTDR for short fibre links is restricted by the near end reflection which causes the so called dead zone. Within the dead zone no information of the fibre link can be obtained. The length of the dead zone depends on the pulse duration used in the OTDR and at the shortest it may be approximately 5 m. The effect of the dead zone can be eliminated by using a sufficiently long launch cord.

The OTDR is one of the basic equipment in measuring optical fibres. It can be used in installation and in troubleshooting. The following technical characteristics should be found out when purchasing an OTDR:

- Available wavelengths
- Spectral width of the test signal
- Maximum attenuation which can be measured
- Shortest length which can be measured
- Accuracy of length measurement
- Accuracy of refractive index setting
- Accuracy of cursor positioning
- Automatic functions, PC interfaces and file formats

Figure 9.3 shows an example of OTDR.



Figure 9.3. Example of OTDR.

OTDR to be used for measuring PON networks shall have some special characteristics, which should be considered if OTDR is purchased also for PON measurements. The following characteristics are important if OTDR is used to measure a PON network through a splitter:

- Maximum attenuation which can be measured shall be greater than the maximum allowed attenuation of PON network.
- Duration (length) of the dead zone should be as short as possible
- At least the following wavelengths shall be available: 1310 nm, 1490 nm and 1550 nm.
- Linearity shall be very good and recovery time should be very short.
- OTDR shall enable setting the attenuation steps which allow great losses of splitters (even 17 dB or more) so that these steps are not interpreted as fibre ends.

OTDR with appropriate PON characteristics can display also the events, which are in the network after the splitter. This kind PON optimized OTDR can thus be used for measuring the whole PON network from OLT to ONUs.

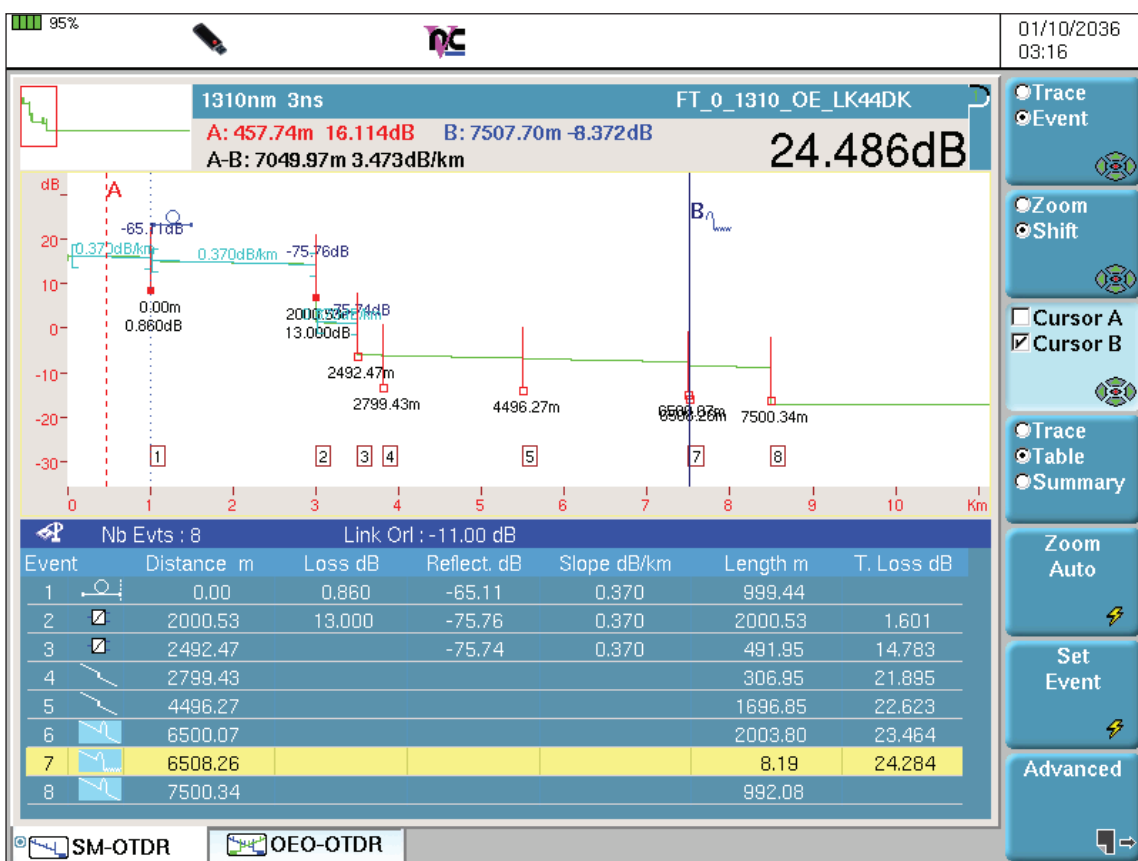

Figure 9.4. Example of display of PON optimized OTDR. The measurement extends from OLT to ONUs.

## 9.2 Measurement of attenuation with light source and power meter

The attenuation of the optical fibre can also be measured with an light source and a power meter (LSPM). This measurement is suitable especially for short single links consisting of optical fibre cable with terminations at both ends. For such links only the insertion loss is important and the detailed measurement information given by OTDR is not needed. OTDR is also by its nature optimized more for longer links and routes.

The principle of measurement is very simple. The procedure consists of two stages: reference measurement and link measurement. In the reference measurement the light source is connected directly to the power meter and the reference level  $L_0$  is measured in dBm. Standard IEC 61280-4-2 specifies three different reference methods: one test cord method, two test cords method and three test cords method. Here we describe only the one test cord method. When using the one test cord reference method the link attenuation measurement gives the attenuation of the link including connections at both ends. The one test cord reference method is illustrated in figure 9.5a.

a) Reference measurement

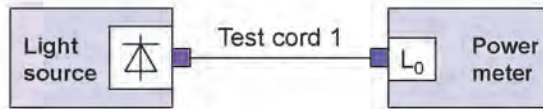

b) Link measurement

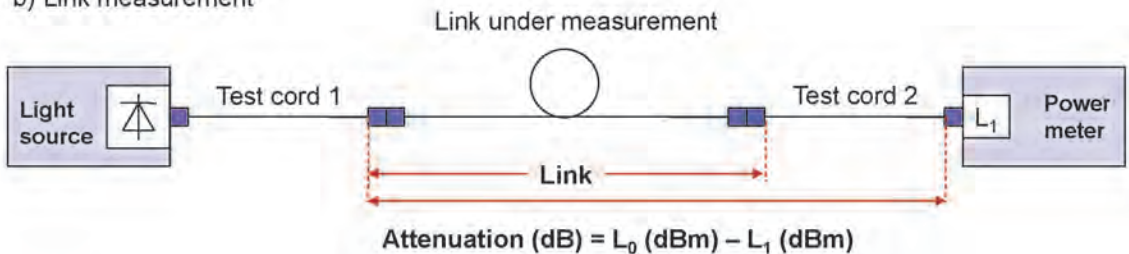

Figure 9.5. Measurement of attenuation with light source and power meter and using the one test cord reference method. Note: The attenuation of the test cord 2 fibre is negligible.

When the reference measurement has been completed, the link to be tested is connected to the light source (with test cord 1) and to the power meter (with test cord 2) and the power level  $L_1$  is measured in dBm. This is illustrated in figure 9.5b. The difference between power levels  $L_0$  and  $L_1$  is the link attenuation (dB).

When light source/optical power meter equipment without memory is used, the results shall first be recorded manually, i.e. in writing, and later they can be written in a spreadsheet file. More advanced models are provided with reference measurement saving and zero setting, automatic functions of measurements and result saving. These equipment displays the attenuation measurement results directly and no manual or computer aided calculations are needed. Modern equipment is also provided with USB connection, which enables easy data transfer to computer.

When optical source and power meter are purchased, it is recommended to purchase also the required reference cords at the same time. It is also important to acquire the information of the output power level of the light source and the sensitivity of the power meter.



Light source

Optical power meter

Figure 9.6. Light source and optical power meter.

### 9.3 Fibre continuity test

Fibre continuity test can be used to ensure the correct connection and polarity of fibres within the optical fibre link. Fibre continuity test can be made with OTDR or light source/power meter. Fibre continuity test can also be performed by using a visible light laser.

### 9.4 Cleanliness

It is recommended that the end faces of the connectors at each end of the link are inspected before testing commences. This is to ensure that the connectors are clean and free from any damage. If there is any dirt present then the connector end face should be cleaned in order to obtain reliable test results and satisfactory long term performance. Following cleaning procedures best practice is to re-inspect to ensure cleaning effectiveness. The ends of optical fibre connectors shall be protected with dust caps, always when not in use.

Cleanliness can be ensured only by using a microscope designed for this purpose or a video microscope. Magnification factor should be at least 200. A video microscope with inspection probes is recommended to be used to carry out this inspection safely with no risk to eyesight from energized fibres. This system also permits the inspection of the end faces of connectors installed behind patch panel connector field without risk of damage or interruption of traffic on other fibres. In addition most video microscopes also enable saving of end face images for documentation and/or for analyzing purposes. Acceptance criteria for dirt and defects that may be tolerated without adverse effect on optical performance are specified in IEC /EN 61300-3-35. Testing with IEC 61300-3-35 criteria is most easy with video microscope and automatic scanning software which makes the PASS/FAIL decision quickly and reliably.



Figure 9.7. Example of an video microscope system with automatic inspection software.



Cleaning cassettes, special cleaning tools and cotton swabs are recommended for cleaning the connector end face. Examples of these are shown in figure 9.8. More recommendations on cleaning methods and cleaning tools are described in IEC TR 62627. It is a very useful guide.

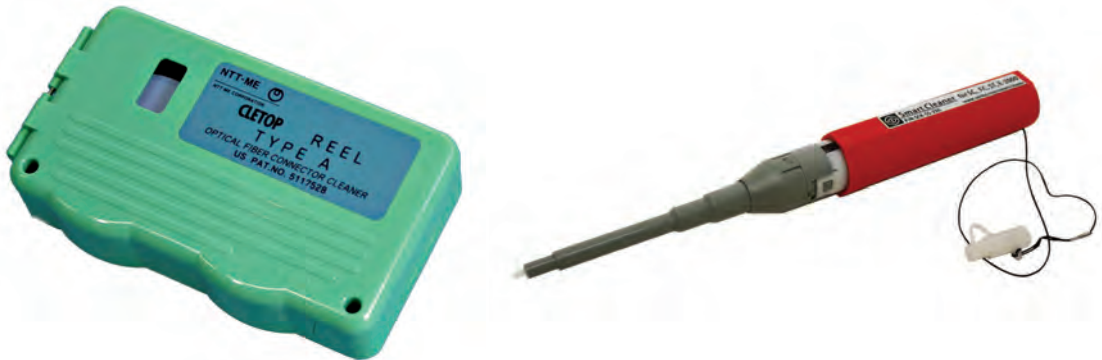

Figure 9.8. Cleaning cassette and cleaning stick.

### 9.5 Saving and documentation of measurement results

Modern measurement equipment enables electronic saving of measurement results. Most equipment is provided with USB interface and memory card, which enable easy transfer of measurement data to computer and on saving the data on CD.

The CDs should be labelled clearly with all relevant measurement information, such as the identification data (name, route etc.), measurement date and the name of measurement operator.

In addition to detailed measurement results a summary table of results should be produced. This summary should give quickly an overview of the route characteristics. The summary should include the following:

- Name and length of link or route
- Measurement date and the name of measurement operator.
- Name, model and other relevant data of the measurement equipment
- Average attenuation (dB/km) of each fibre at wavelength of 1550 nm
- Splice losses exceeding the specified value (e.g. 0,2 dB) and attenuation steps between the splices exceeding 0,1 dB.

## 10 Documentation and maintenance

### 10.1 Documentation

The implementation of an optical fibre link or network begins from planning and comes to end with the measurements after the installation. After this the link or network needs maintenance activities during its whole lifetime. The network may also be modified or expanded. For managing all these activities proper documentation is needed and it has an essential role. Modern information technology offers excellent tools for documentation, but also manual documentation fulfils its functions, if done well. Whatever methods are used for documentation it is important that all information needed in planning, connections, modifying, expanding and troubleshooting are systematically recorded and easily available.

Network maps are drawn up of outside plant. These maps should show cable routes and locations of ducting, manholes and distributors. Network maps are drafted by updating the network maps of the planning phase so that that the final documentation corresponds to the real network as it has been installed. Also the locations of buildings are marked in the network maps. In addition to network maps also cabling schemes are drafted. These schemes include all essential and necessary information needed in changes and fault location of the network. It is recommended that the cabling schemes include the following information:

- Optical fibre cable route
- Cable manufacturer(s), cable types and drum numbers
- Joints:
  - Joint numbers
  - Distances of joints from the end of the line based on OTDR measurement
  - Locations of joints in terrain, e.g. manhole and possible GPS data
  - Lengths of the branches leaving the joint
  - Information of the possible extra cable lengths at the joints, e.g. at bridges
  - Cable length markings at joints
  - Manufacturer and type of joint closure
- Manufacturer and type of patch panels and termination boxes
- Connector type at termination points

The cabling scheme should be a clear document including only the essential data for the maintenance of the network. It can be based e.g. on Excel spreadsheet.

In addition to the network map and cabling scheme the measurement results (see clause 9.5) are included in the final documentation.

Many cables may leave from and come to the joints of the optical network. In urban areas there may also be joints of more than one teleoperators in the manholes. In these cases it is very important that all cables, ducts and pipes and joint closures are provided with relevant markings, which serve changes and fault location.

### 10.2 Maintenance

#### 10.2.1 Tasks of maintenance

The maintenance of the optical access network consists of all the tasks and activities which are needed to ensure the reliable function and service of the network, managing the changes and preventing and repairing faults during the whole lifetime of the network.

Thus at the minimum the maintenance consists of the following items:

- Definitions of the network, services provided by the network and the interconnection interfaces of the network.
- Definition and publication of the maintenance organization and the persons responsible of maintenance.
- Management and distribution of documentation, cable location information services.
- Maintaining the change and expansion plans of the network.
- Scheduling and informing the change works.
- Management and control of active equipment of the network.
- Control and statistics of quality of service.
- Performing periodic inspections.
- Planning, preparing and arranging repair activities.

The owner of the network may itself take care of all maintenance activities or it may totally or partly use outsourced maintenance services. Also in the case of outsourcing the owner of the network should ensure the quality of the maintenance of the network.

It should be noticed that the quality of documentation produced during planning and implementation of the optical network and the availability of associated information systems mostly determine the basis for the fault repair and change works of the network. Therefore planning of these procedures should be carried out already before the building and construction of the network.

### 10.2.2 Principles of repair

Faults may be significantly prevented with careful and well planned maintenance, but still faults inevitably appear from time to time. The fault may appear in the passive section of the network or in active equipment. Therefore the maintainer of the network shall be aware of all possible fault points and define the target levels and response times of the fault repair activities. Also the procedures and resources for fault reporting and repair should be planned and reserved.

The owner of the network may itself take care of all fault repair activities or it may totally or partly use outsourced repair services. Also in the case of outsourcing the owner of the network should ensure the quality of the repair activities.

In maintenance of optical fibre links care and cleanliness are extremely important. Especially moisture and dust should be kept away during fibre splicing. Handling of cables and fibres in splice closures, termination points and distributors should be non-disturbing. This means that no more disturbances are caused for the traffic in fibres than is necessary for the fault location and reparation.

The failure in an optical fibre system is generally noticed when the system gives an alarm. In troubleshooting it should first be found out whether the fault is in equipment or in cable network. If the fault is in the cable network, it should be located. Typically faults appear in splices or connections, but also the cable may be damaged. The OTDR is a useful tool for fault location. Based on the alarm information it is often easy to find out the point of the network (e.g. ODF), up to which the network operates correctly. From this point the cable network can be tested to the direction, where the fault exists. The distance of the fault from the testing point can be then read on the OTDR display. Based on this distance and the documentation of the network the physical or geographical location of the fault can then be found out.

The following principles should be followed in fault location:

- OTDR test is carried out from the nearest possible point to the fault.
- OTDR test is carried out from two directions to the fault. This gives better accuracy if the fault is not a single point, but has a certain length.

- It should be noted that the distance given by the OTDR is the fibre length. In the cable the fibre length, however, is greater than the cable length. The values of the excess fibre lengths for different cable types can be obtained from cable manufacturers.

Although the fault would appear in only one fibre, also all the other fibres should be checked with the OTDR. This is very important in the case of cable damage, when several fibres often are damaged in some degree. Maybe the link operates still with less damaged fibres, but in future the attenuation may be increased.

When the fault has been located, it should be repaired as quickly as possible. Especially when there is no backup link, no time should be lost. The repair splice may be final or temporary. The temporary splice may then be completed to final repair splice later when the traffic in the cable is low or it is in the backup cable. If the fusion splicer is not available quickly, mechanical splices can be used in temporary splicing. Also special emergency cables may be used if such are available. In figure 10.1 is shown an example of an emergency cable kit. Maintenance and repair strategy should be planned carefully and all required activities, resources and materials should be available all the time. The repair team should have a well-equipped tool set for repair situations. This tool set should include the following:

- Optical source and power meter
- Mechanical splices (10 pcs)
- Fibre stripper
- Fibre cleaver
- Alcohol for cleaning
- Heater



*Figure 10.1. An example of an emergency cable kit.*



Figure 10.2. Examples of cable faults.

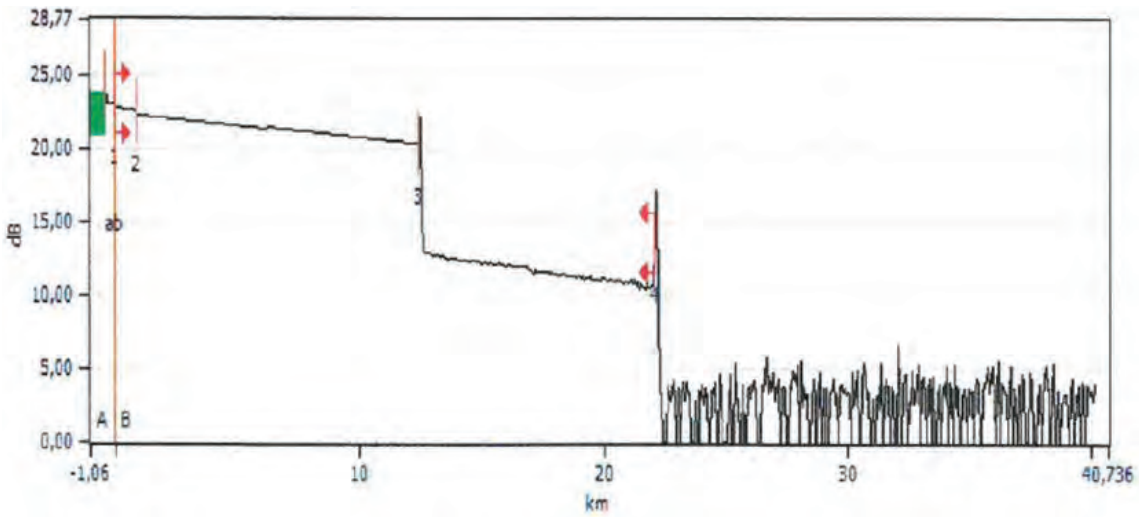

Figure 10.3. OTDR curve from a cable fault as a sharp stone is pressing a buried cable after installations.



## Appendix 1: Abbreviations

ADM	add drop multiplexer
ADSL	asymmetric digital subscriber line
ANSI	American National Standards Institute
APC	advanced PC =super PC
APC	angle PC
APD	avalanche photodiode
APON	ATM passive optical network
ATM	asynchronous transfer mode
AWG	arrayed waveguide grating
BD	building distributor
BER	bit error ratio
BPON	broadband passive optical network
BW	bandwidth
CAT 5	category 5
CAT 6	category 6
CATV	cable television
CD	campus distributor
CENELEC	Comite Europeen de Normalisation Electrotechnique
CSMA/CD	Carrier Sense Multiple Access with Collision Detection
CWDM	coarse wavelength division multiplexing
DFB	distributed feedback (laser)
DPON	Docsis PON (passive optical network)
DS	dispersion shifted
DSL	digital subscriber line
DSLAM	Digital Subscriber Line Access Multiplexer
DVB	digital video broadcasting
DVB-C	digital video broadcasting for cable television
DVB-S	digital video broadcasting for satellites
DVB-T	digital video broadcasting for terrestrial systems
DWDM	dense wavelength division multiplexing
DXC	digital cross connect
EFM	Ethernet in the first mile (IEEE 802.3ah)
EIA	Electronic Industries Association
EN	Norme Europeenne
EoVDSL	Ethernet over VDSL
EPON	Ethernet passive optical network (IEEE 802.3ah and IEEE 802.3av)
ESCON	Enterprise System Connection
FC	FC connector
FD	floor distributor
FDDI	fibre distributed data interface
FP	Fabry-Perot (laser)

FR	flame retardant
FRP	fibre reinforced plastic
FTP	foiled twisted pair
FTTB	fibre to the building
FTTC	fibre to the curb
FTTH	fibre to the home
FTTN	fibre to the node
FOTP	fibre to the premises
GBIC	gigabit interface converter
GI	graded index
GPON	gigabit capable passive optical network
HF	halogen free
IEC	International Electrotechnical Commission
IL	insertion loss
IP	internet protocol
IPTV	IP-television
IR	infrared
ISDN	integrated services digital network
ISO	International Organization for Standardization
ITU	International Telecommunication Union
LAN	local area network
LC	LC connector
LD	laser diode
LED	light emitting diode
LS	low smoke
LSPM	light source – power meter
MAN	metropolitan area network
MCVD	modified chemical vapour deposition
MFD	mode field diameter
MLM	multi-longitudinal mode
MM	multimode
MT-RJ	MT-RJ connector
MU	MU connector
NA	numerical aperture
NC	non-corrosive
OADM	optical ad-drop multiplexer
ODF	optical distribution
O/E	optical/electric
OM	multimode fibre category in generic cabling systems ( OM1, OM2, OM3 and OM4)
ONU	optical network unit
ONT	optical network terminal
OLT	optical line terminal

OPGW	optical ground wire
OTDR	optical time domain reflectometer
OVD	outside vapour deposition
P2MP	point-to-multipoint
P2P	point-to-point
PAS	profile alignment system
PC	physical contact
PCM	pulse code modulation
PDH	plesiochronous digital hierarchy
PE	polyethylene
PIN	PIN-diode
PMD	polarization mode dispersion
PON	passive optical network
POTS	plain old telephone services
PVC	polyvinyl chloride
RFoG	RF over glass
ROADM	reconfigurable optical add-drop multiplexer
RL	return loss
SC	SC connector
SC-D	SC-duplex
SDH	synchronous digital hierarchy
SFF	small form factor
SFP	small form factor pluggable
SG	SG connector (=VF-45)
SHDSL	single-pair high-speed digital subscriber line
SM	singlemode
SMA	SMA connector
SLM	single-longitudinal mode
SPC	super PC
ST	ST connector
STB	set-top box
STM	synchronous transport module
STP	screened twisted pair
TCP	transmission control protocol
TO	telecommunications outlet
UDP	user datagram protocol
UPC	ultra PC
UTP	unscreened twisted pair
UV	ultraviolet
VAD	vapour phase axial deposition
VCSEL	vertical cavity surface emitting laser
VDSL	very-high-speed digital subscriber line
VF-45	VF-45 connector (=SG)

VLAN	virtual local area network
VoD	video on demand
VoIP	voice over IP
WAN	wide area network
WDM	wavelength division multiplexing
WLAN	wireless local area network
ZH	zero halogen







# nestor cables



## NesCon connectivity

### Installation and connection accessories for fibre optic networks

Nestor Cables' NesCon product family includes essential installation and connection accessories for fibre optic networks, from ODFs to joint closures and terminations. In addition to the numerous individual NesCon products, we also provide complete solutions for fibre optic networks.



Our own product development capabilities and expertise, reliable and first-rate partners, as well as our own production and testing process guarantee Nestor Cables' position as a reliable, flexible and cost-effective supplier of fibre optic accessories.

Nestor Cables guarantees the compatibility between NesCon products and Nestor Cables' optical fibre cables.

[www.nestorcables.com/nescon-connectivity](http://www.nestorcables.com/nescon-connectivity)

# FTTx

## Principles, Technologies and Installation Solutions

FTTx – Principles, Technologies and Installation Solutions is intended as an introduction to FTTx technologies and solutions for interested professionals as well as students. This book concentrates on the practical aspects of this rapidly growing field. The basic optical transmission theory is discussed on the level needed for the readers to understand the fundamentals of optical fibre cables and components. High emphasis is also put on network planning, installation and documentation as they are essential matters for the network to be easily maintained and upgraded for future needs.

Nestor Cables Ltd. is a trusted Finnish supplier and manufacturer of fibre optic cables and fibre optic cable accessories, copper telecommunication cables and cables for industry and military purposes. Nestor Cables' modern factory is located in Oulu in Northern Finland. Nestor Cables' success is based among other things on professional personnel, very modern production facilities and processes as well as flexibility, high quality and on-time deliveries. The factory was taken into use in 2008.

In addition to Nestor Cables remarkable position in Finland, Nestor Cables is also active in the other Nordic countries, Russia, several Baltic countries, the USA, Africa and the Middle East. Nestor Cables has developed a wide selection of products and solutions for FTTx applications. Nestor Cables' fibre optic connection products together with accessories form NesCon product family. NesCon products are fully compatible with all fibre optic cables produced by Nestor Cables. All products are designed to operate even in the most demanding environments. Nestor Cables – Quality from Finland.



[www.nestorcables.com](http://www.nestorcables.com)

[info@nestorcables.fi](mailto:info@nestorcables.fi)

[forename.surname@nestorcables.fi](mailto:forename.surname@nestorcables.fi)

Mittarikuja 5, 90620 Oulu, Finland